

POLYMER SEALS

Engineered Solutions

PRODUCT SELECTION GUIDE

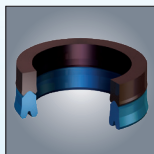

**Reciprocating
Sealing
Solutions**



**Rotary
Sealing
Solutions**



**Static
Sealing
Solutions**



**Spring
Energized
Sealing
Solutions**

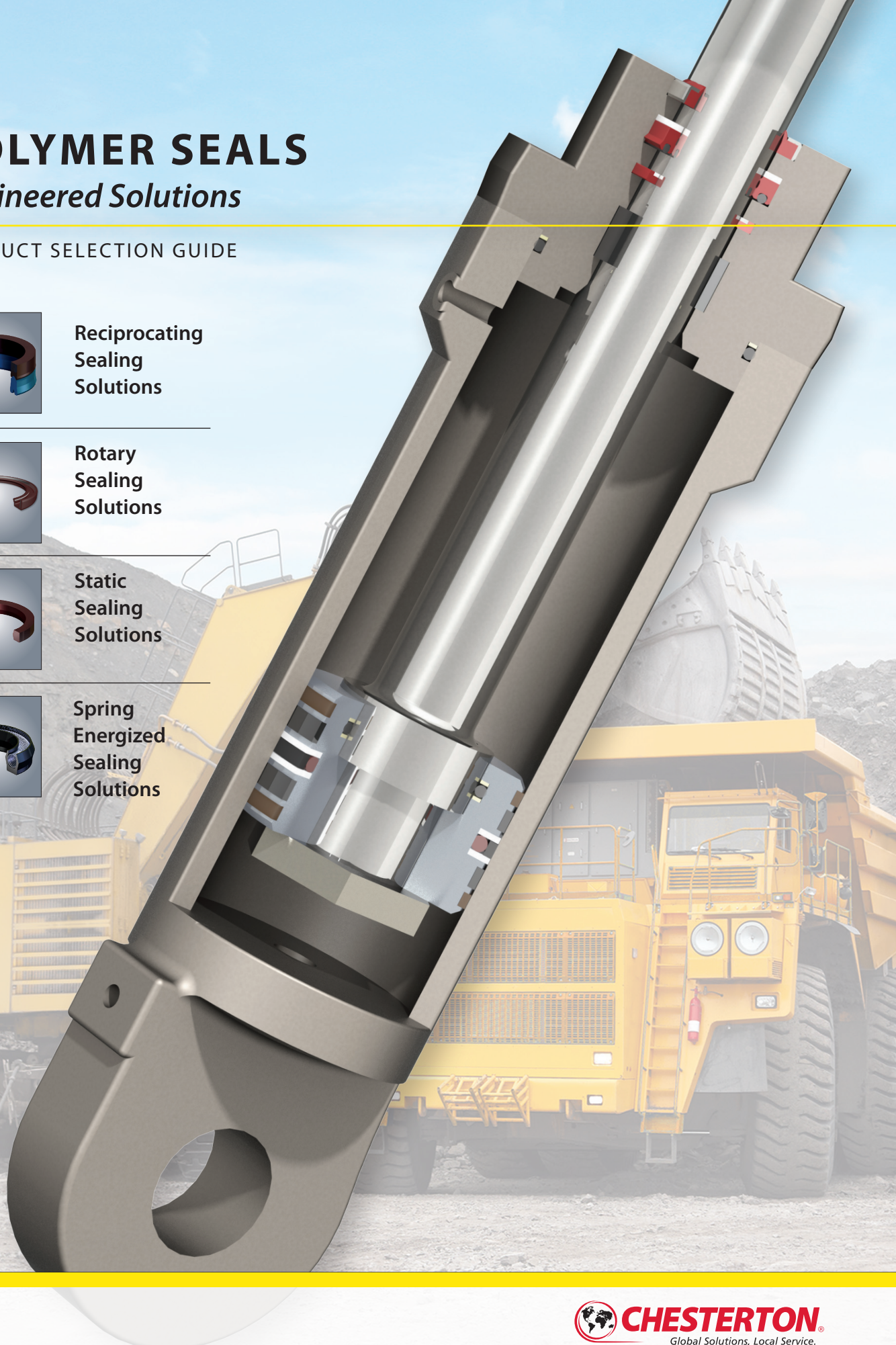

High Performance Polymer Seals Engineered Solutions

Improve Equipment Reliability and Productivity, Reduce Maintenance and Operating Costs, Optimize Equipment Efficiency

In most heavy industries the need for consistent, high performance sealing solutions for fluid power reciprocating equipment, rotary and specialty equipment—specifically in demanding operating conditions and harsh environments—is mostly undervalued until it is too late, resulting in expensive equipment shutdown, repair and replacement, environmental and safety issues, and unbudgeted extra labor costs. Under-performing sealing solutions can even reduce the energy and resource efficiency, significantly impacting plant profitability.

The Chesterton® Polymer Seals Engineered Solutions life cycle approach is a contemporary way of support to achieve customer's asset/equipment life cycle management and plant-wellness goals.

Chesterton offers a broad range of innovative products and comprehensive programs focused on fluid power and rotary and specialty equipment reliability improvement. From high performance hydraulic and pneumatic seal systems that improve efficiency and reduce leakage, to rotary seals protecting expensive bearings and gearboxes, and to special spring energized seals for ultra high-pressure and high-temperature applications in most challenging specialty equipment, Chesterton offers a full range of solutions to:

- Reduce Premature Failure
- Improve Reliability
- Reduce Repair, Maintenance, and Operating Costs
- Extend Equipment Life
- Optimize Performance



TABLE OF CONTENTS

How to Use This Catalog	4
Placing an Order	5
Chesterton Polymer Seals Programs	6 – 7

SEALING PRINCIPLES

Seal Selection Guides	8 – 9
Recommended Seal Sizes and Standard Housing Dimensions	10 – 11
Standard Fits and Tolerances Data Chart	12

RECIPROCATING SEALING SOLUTIONS

Wipers

21K (Wipers)	13
CW21K (Canned Wiper)	14

Rod and Piston Seals

22K (Negative Lip U-Cup Seals)	15
22KN (Neutral Lip U-Cup Seal)	16
22KE (O-Ring Energized U-Cup Seal)	17
20K (Bidirectional Compression Seal)	18
23K (Pneumatic U-Cup Seals)	19
CCS (Custom Cap Seals)	20
P7K (Reinforced Piston Cup Seal)	21

Bearing Elements and Anti Extrusion Rings

9K (Anti-extrusion Rings)	22
18K (Inch)/19K (Metric) Bearing Band	23
16K (Metric)/17K (Inch) Bearing Band Strip	24 – 25
WR (Custom Wear Rings)	26 – 27

Stacked Assemblies

R600 (Compression V-Ring Stacked Set)	28 – 29
27K (V-Ring Stacked Set)	30 – 31
11K (Two Piece Split Stacked Set)	32

ROTARY SEALING SOLUTIONS

Continuous Rotary Seal

30K (Continuous PTFE Lip Seals)	33
30KC (Cartridge Multi Lip Seals)	34
Polymer Labyrinth Seal (PLS)	35
50K (Rotary Face Seals)	36 – 37
51K (Mill Rotary Seal)	38 – 39
52K (Reinforced Mill Rotary Seal)	40 – 41
53K (Premium Mill Rotary Seal)	42 – 43

Split Rotary Seals

24K (Slow Rotary Seal)	44
33K (Low Pressure Rotary Seals)	45
Matrix (Low Pressure Rotary Seal)	46
SPLS (Split Polymer Labyrinth Seal)	47

Restriction Bushing and Lantern Rings

14K (Restriction Bushings)	48
14KLR (Lantern Rings)	49

STATIC SEALING SOLUTIONS

D-Rings

20KD (Static Compression Seals)	50 – 51
---------------------------------------	---------

O-Rings

OR (Face and Static Seals)	52 – 53
----------------------------------	---------

SPRING ENERGIZED SEALS

100 Series (Cantilever Spring Design)	54 – 55
200 Series (Elliptical Coil Spring Design)	56 – 57
300 Series (Helical Wound Spring Design)	58 – 59
500 Series (Stacked V-Ring Seals)	60
600 Series (Continuous Contact Seals)	61

COMPREHENSIVE SEALING PORTFOLIO

Common Profiles	62 – 63
Profile Guide	64 – 76
Seal Materials	77 – 78

ENGINEERING GUIDE

Fluid Compatibility Guide	79 – 83
Application of ISO Standards Fits and Tolerances	84 – 85
Miscellaneous Hardware Guidelines— Reciprocating	86 – 87
Miscellaneous Hardware Guidelines— Rotary and Reciprocating	88
Miscellaneous Hardware Guidelines— Replaceable Wear Rings	89 – 91
Allowable Diametrical Clearance	92 – 94
Dynamic Sealing Surface Hardness	95 – 96
Surface Roughness	97 – 98
Operating Temperature Range	99
Engineering Action Request Form	100
Equipment Dimensioning	101
EPS Industrial Cylinder Survey for Reciprocating Applications	102 – 103
Sealing Technology	104

Important Note: This Catalog provides general guidelines and information about product operating conditions and options for experienced users to consider. Operating conditions not referred to in this Catalog may affect product selection and/or performance. This Catalog should not be considered advice, a guarantee of product performance, or a replacement for obtaining product application advice from a qualified professional. A.W. Chesterton Company and its affiliates assume no responsibility for any action or inaction you take based on or made in reliance with the information contained in this document.

How to Use This Catalog

USAGE

The catalog can be used to locate product using two different methods:

- By means of the **Table of Contents**
- By means of the **Product Selection Guide**

TABLE OF CONTENTS

Search the table of contents based on product type to quickly identify products offered.

- Section I** – Sealing Principles
- Section II** – Reciprocating Sealing Solutions
- Section III** – Rotary Sealing Solutions
- Section IV** – Static Sealing Solutions
- Section V** – Spring Energized Seals
- Section VI** – Comprehensive Sealing Portfolio
- Section VII** – Engineering Guide

RECIPROCATING SEAL SELECTION GUIDE

Use the Reciprocating Seal Selection Guide if you need help identifying the appropriate product for your application. The product matrix was developed using motion and application speed as the foundation.

To use the guide:

- Confirm application speed
- Identify product offerings
- Locate page to review details

PRODUCT SECTION

Reference the product section, where all products are listed by type. Each product data sheet contains the following information.

- A** Product name and type
- B** Product description
- C** Technical data
- D** Equipment drawing
- E** Family of profiles
- F** Features and benefits
- G** Notes for placing an order

21K Wipers
Limits contaminants from entering system

• Single-acting, abrasion-resistant design for hydraulic and pneumatic applications

• Positive rake lip design effectively wipers contaminants away from surface

• Manufacturing process allows flexibility to create any size

• Gaps made to accommodate international standards including ISO and DIN

Placing an Order

To place an order, the required information is needed:

- Product profile
- Product material
- Equipment dimensions

For example:

To place an order for a hydraulic rod seal with a 50 mm rod diameter, a bore diameter of 70 mm, and a seal groove height of 15 mm, the following information is required:

To place an order: Rod Seal

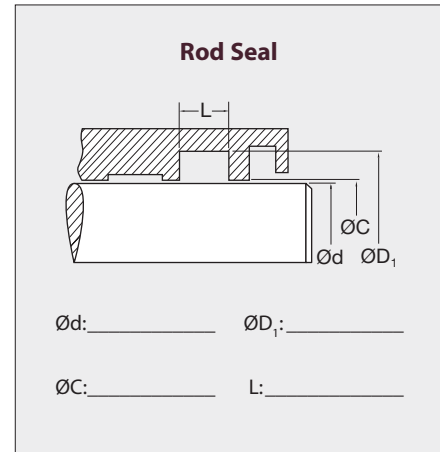
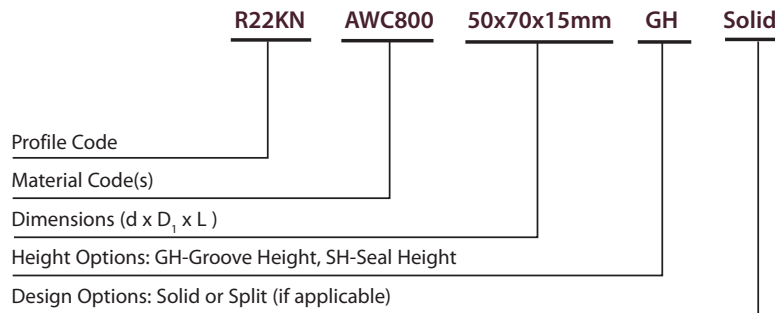

R22KN

Catalog Legend

Designations used throughout this catalog

A	Center piston landing area	G	Wiper/seal lock groove depth
b	Maximum extrusion gap	H	Seal or wiper overall height
d	Rod, shaft, or ram diameter	H₁	Bearing band height
d₁	Piston seal groove diameter	H₂	Flange thickness
d₂	Piston bearing band groove diameter	J	Rod seal support clearance diameter
d₃	Wiper lock groove diameter	L	Seal groove height
d₄	Hold down plate diameter	L₁	Wiper groove height
d₅	Piston clearance diameter	L₂	Bearing band groove height
d₆	L shaped, anti-extrusion ring leg inner diameter	L₃	Working stuffing box height
C	Rod clearance diameter	L₄	L shaped, anti-extrusion ring leg height
c/s	Cross section	M	Inboard/outboard piston landing area
D	Cylinder bore diameter	OR	O-Ring
D₁	Rod seal groove diameter/stuffing box bore	P	Piston seal support clearance diameter
D₂	Wiper housing lip clearance diameter	R	Radius
D₃	Rod bearing band groove diameter	R_c	Running clearance
D₄	Wiper groove diameter	S	Cross section
D₅	Wiper lock groove	ID	Inner diameter
E	Overall piston head length	OD	Outer diameter

Chesterton Polymer Seals Programs



Speed of Service

Dedicated Service Centers

Chesterton is a technology leader in the polymer seal industry. Our SpeedSeal™ capability brings same-day service of this advanced technology to customers worldwide. Strategically located and integrated service centers use innovative manufacturing methods to provide you with the broad selection of proven designs and wide range of high performance materials.

Superior Materials

World-Renowned AWC800 Polymer

Chesterton's world-renowned AWC800 material is one of the highest performing polyurethane materials for heavy-duty fluid power applications on the market today. In addition, we utilize the full range of advanced materials for the most demanding applications.

- Polyurethanes
- Engineered plastics
- Fluoroplastics
- Elastomers (rubbers)



Engineered Solutions

High Performance Custom Seals

We leverage our engineering experience in design and materials to develop custom seals that solve today's most difficult sealing challenges. Our custom designs provide leading-edge technology that has been used around the world with documented success and recognition.

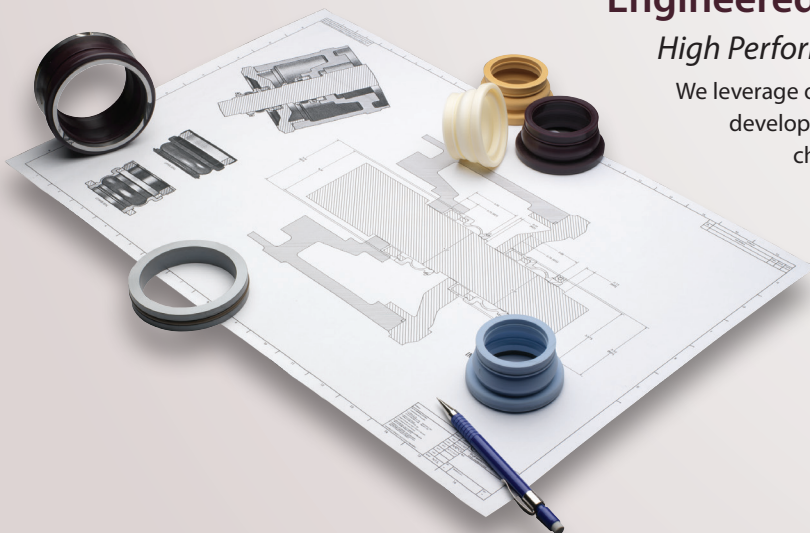

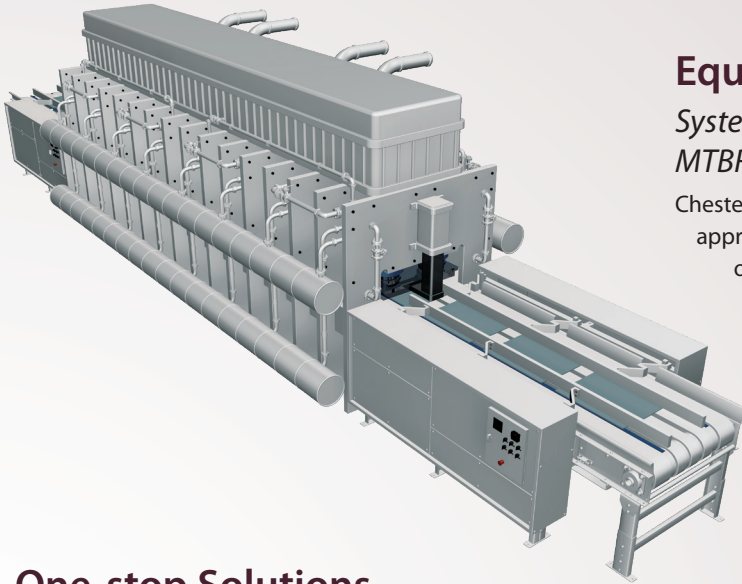

Equipment Upgrade

Systematic Approach to Improve MTBR and Reduce MTTR

Chesterton's equipment upgrade program applies a systematic approach for improving seal performance during repair and overhaul of equipment. This approach, in combination with high performance sealing products and systems, will assist to improve equipment reliability, availability, and performance productivity.

One-stop Solutions

Wide Range of Product Portfolio

We specialize in the development, design, and manufacture of system solutions tailor-made to customer's requirements. Polymer sealing products is the term to describe the broad range of sealing devices to provide sealing function in all types of fluid power and associated equipment in dynamic linear, rotational, and oscillating motion.



Customer Support

Global Solutions, Local Service

Chesterton's skilled field specialists work in collaboration with customers to understand their needs and provide the best solution for their applications. Our local service is supported by a global distribution and logistics network that enables us to reach and react to the shifting needs of industrial customers around the world.

Global Training Programs

The Know-How Advantage

Build a skilled workforce of fluid power equipment specialists by providing Chesterton's maintenance and operational best practices training to impact reliability, efficiency, and life cycle costs. Chesterton has been in the business of providing knowledge of this type for decades and can assist you with your training and development needs.









Seal Selection Guide

Please contact your local Chesterton® representative to help you select the best product for your application.

Reciprocating Sealing Solutions

For most hydraulic applications including, but not limited to light-, medium-, and heavy-duty hydraulics used in mining/mobile and underground cylinders, industrial cylinders, injection molding presses, steel mill hydraulic presses, and automotive hydraulics, the following standard profiles will be adequate. For special profiles and requirements, Chesterton offers more than 175 different profiles to pick from per specific application needs.





Seal Picture	Seal Type	Seal Profile	Config-uration	Product Page	Function	Seal Material Recommended	Max Operating Speed m/s (ft/min)	Operating Temp. Range °C (°F)	Max Operating Pressure MPa (psi)	Seal Size mm (in)
	Rod Seal	22K	Piston/Rod	11	Rod Seal to retain hydraulic fluids within the cylinder. significantly minimizes leaks along static/dynamic surfaces.	AWC800 (95A Thermoset Polyurethane)	1 (200)	-50 – 85 (-60 – 185)	105 (15,000)	6 – 2540 (1/4 – 100)
						AWC860 (95A Thermoset Polyurethane)	1.25 (250)	-50 – 120 (-60 – 250)		
	Wiper/Scraper	21K	Rod	18	Wiper/Scraper to exclude contaminants, keep abrasives out of the cylinder.	AWC800 (95A Thermoset Polyurethane)	1 (200)	-50 – 85 (-60 – 185)	N/A	6 – 2540 (1/4 – 100)
						AWC860 (95A Thermoset Polyurethane)	1.25 (250)	-50 – 120 (-60 – 250)		
	Bearing Elements	18K/19K	Rod	24	Split Bearing to minimize metal to metal contact, reduce radial movement.	AWC660 40% Glass-filled Nylon	1.25 (250)	-40 – 121 (-40 – 250)	N/A	Up to 500 (20)
	Cap Seal (Piston/Rod)	CCS	Piston/Rod	17	Bidirectional Cap Seal to reduce friction and stick slip effects.	O-Ring Material: FKM, NBR Cap: Several Filled PTFE grades. AWC500 - Bronze Filled PTFE	15 (3,000)	-35 – 200 (-30 – 400)	35 (5,000)	Up to 600 (24)
						Polyurethane, AWC860	1.25 (250)	-35 – 120 (-30 – 250)		6 – 1320 (1/4 – 52)
	Stacked Set	11K	Piston/Rod	25	Single-acting, two-piece split, Stacked Set for hydraulic cylinders and presses. significantly minimizes shimming. Reduced friction vs V-ring sets.	AWC800 (95A Thermoset Polyurethane)/AWC825 (85A Thermoset Polyurethane)	1 (200)	-50 – 85 (-60 – 185)	105 (15,000)	6 – 2540 (1/4 to 100)
	Stacked Set	27K	Piston/Rod	29 – 29	Single-acting V-ring set for heavy duty hydraulic applications.	AWC800 (95A Thermoset Polyurethane)	1 (200)	-50 – 85 (-60 – 185)	105 (15,000)	6 – 2540 (1/4 to 100)
						AWC860 (95A Thermoset Polyurethane)	1.25 (250)	-50 – 120 (-60 – 250)		
						AWC704 (85A FKM)	1.5 (300)	-35 – 200 (-30 – 400)	16 (2,320)	6 – 304.8 (1/4-52)

Seal Selection Guide

Please contact your local Chesterton representative to help you select the best product for your application.





Rotary Equipment Solutions

For most Rotary applications including, but not limited to, bearing protection on industrial pumps, conveyor belts, and rotary swivel joints the following profiles should be adequate. For special requirements and profiles, Chesterton has a database of 175+ profiles to choose from for specific requirements. All rotary seals are made to order.

Seal Picture	Seal Type	Seal Profile	Product Page	Function	Seal Material Recommended	Max Operating Speed m/s (ft/min)	Operating Temp. Range °C (°F)	Max Operating Pressure MPa (psi)	Seal Size Range mm (in)
	High Speed Continuous Rotary Lip Seal	30K	31	Continuous Lip Seal for bearing protection, reduced shaft wear	Filled PTFE AWC300 – Moly & Glass AWC400 – Carbon & Graphite	20 (4000)	150 (300)	0.7 (10)	20 – 508 (0.787 – 20)
	Split Rotary Seal	33K	43	Split Rotary Seal for ease of installation without the need for equipment disassembly.	Holder: Polyurethane (AWC800) Sealing element: Filled PTFE AWC300 – Moly & Glass AWC400 – Carbon & Graphite	12.7 (2500)	85 (185)	Flush applications	25 – 600 (1 – 24)
	High-Pressure Slow Rotary Seal	24K	42	Unidirectional Split Rotary Seal for very low speed applications	AWC800/AWC 860	0.5 (100)	120 (250)	105 (15,000)	6 – 2540 (1/4 – 100)
	Rotary Seal for High Runout	Matrix Rotary Seal	44	Split Rotary Seal for large shaft runout and worn shafts	AWC860/1727NP	15 (3000)	120 (250)	Fluid splash to 0.3 bar (5 psi)	50 – 890 (2 – 30)
	High Speed Non Contact Labyrinth Seal	PLS	33	Noncontact Seal for gearboxes, pumps in splash applications	AWC800	30 (6000)	85 (185)	Fluid splash	25 – 508 (1 – 20)
	Spring Energized Seal	SES 100	52 – 53	Unidirectional seal for rotary sealing at low/high pressures for a wide range of temperatures	AWC400 - Carbon/ Graphite PTFE	–	200 (400)	15K P.V.	1.2 – 2032 (0.05 – 80)

Static Sealing Solutions

For most hydraulic applications including, but not limited to, light-, medium-, and heavy-duty hydraulics used in mining/mobile and underground cylinders, industrial cylinders, injection molding presses, steel mill hydraulic presses, and automotive hydraulics, the following standard profiles will be adequate. For special profiles and requirements Chesterton offers more than 175 different profiles to pick from per specific application needs.

Seal Picture	Seal Type	Seal Profile	Configuration	Product Page	Function	Seal Material Recommended	Operating Temp. Range °C (°F)	Max Operating Pressure MPa (psi)	Seal Size mm (in)
	Static Compression Seal	20KD	Piston/Rod/ Face	48 – 49	Bidirectional Continuous Compression Seal to replace O-Ring offering better stability and extrusion resistance.	AWC800 (95A Thermoset Polyurethane) AWC860 (95A Thermoset Polyurethane)	-50 – 85 (-60 – 185)	105 (15,000)	6 – 2540 (1/4 – 100)
	Spring Energized Seal (SES) Seal Assemblies	SES 200 Series - Elliptical Coil Spring Energized	Rod	54 – 55	Single-acting with cantilever spring for highly dynamic applications.	AWC400 - Carbon/ Graphite PTFE	-156 – 204 (-250 – 400)	105 (15,000)	1.2 – 2032 (0.05 – 80)
		SES 300 Series - Cantilever Spring Energized	Rod	56 – 57	Single-acting with helical spring for static or slow speeds.				
		SES 600 Series - Continuous Spring	Face	59	Excellent in low temperature heavy duty applications. Best suited for cryogenics.				

Recommended Seal Sizes and Standard Housing Dimensions

When selecting a seal, it is important to use an appropriate seal cross section and height according to hardware diameters of either bore or rod. The tables below give recommended seal cross section and height ranges used for Chesterton products and for standard housing dimensions.

Recommendations from Tables 1 and 2 can be applied to common industry applications for many U-Cup-type seals. For seal stability, the recommended seal height should be approximately 50% larger than the cross section.

U-Cup Seals (22K, 22KE, 22KAER, 22KEAER, 22KN)



TABLE 1 – METRIC

Diameter Range mm		Cross Section Range mm	Height Range mm
Min	Max	Min – Max	Min – Max
-	25	3.00 – 4.00	5.00 – 6.00
>25	50	3.00 – 5.00	5.00 – 7.00
>50	100	4.00 – 7.00	6.00 – 11.00
>100	150	5.00 – 10.00	7.00 – 14.00
>150	200	6.00 – 12.00	10.00 – 19.00
>200	300	10.00 – 16.00	14.00 – 19.00
>300	1250+	12.00+	19.00+

TABLE 2 – INCH

Diameter Range inch		Cross Section Range inch	Height Range inch
Min	Max	Min – Max	Min – Max
-	1.000	0.125 – 0.156	0.187 – 0.250
>1.000	2.000	0.125 – 0.187	0.187 – 0.281
>2.000	4.000	0.156 – 0.281	0.250 – 0.437
>4.000	6.000	0.187 – 0.375	0.281 – 0.562
>6.000	8.000	0.250 – 0.500	0.375 – 0.750
>8.000	12.000	0.375 – 0.625	0.562 – 0.937
>12.000	48.000+	0.500+	0.750+

Rod seal: Cross section (S) = (D₁-d)/2, Piston seal: Cross section (S) = (D-d)/2

Recommendations from Tables 3 and 4, as well as Tables 5 and 6 can be applied to common industry applications for many cap-type seals.

Rod Cap Seals (RCCS, RCCS1, RCCS2, RCCS3, RCCS4)



TABLE 3 – METRIC

Rod Diameter Range mm		Rod Seal Groove Diameter	Seal Groove Height	Seal Cross Section	O-Ring Cross Section
Min	Max	D ₁ H8 mm	L (+200/-0) mm	C/S mm	OR mm
3	7.9	d + 4.9	2.2	2.45	1.78
8	18.9	d + 7.3	3.2	3.65	2.62
19	37.9	d + 10.7	4.2	5.35	3.53
38	199.9	d + 15.1	6.3	7.55	5.33
200	255.9	d + 20.5	8.1	10.25	6.99
256	649.9	d + 24.0	8.1	12	6.99
650	999.9	d + 27.3	9.5	13.65	8.40
1,000+	-	d + 27.3	9.5	13.65	8.40

TABLE 4 – INCH

Rod Diameter Range inch		Rod Seal Groove Diameter	Seal Groove Height	Seal Cross Section	O-Ring Cross Section
Min	Max	D ₁ H8 inch	L (+200/-0) inch	C/S inch	OR inch
0.118	0.311	d + .193	0.087	0.096	0.070
0.315	0.744	d + .287	0.126	0.144	0.103
0.748	1.492	d + .421	0.165	0.211	0.139
1.496	7.870	d + .594	0.248	0.297	0.210
7.874	10.075	d + .807	0.319	0.404	0.275
10.079	25.587	d + .945	0.319	0.472	0.275
25.591	39.366	d + 1.075	0.374	0.537	0.331
39.370 +	-	d + 1.075	0.374	0.537	0.331

Rod seal: Cross-section (S) = (D₁-d)/2

Recommended Seal Sizes and Standard Housing Dimensions

Piston Cap Seals (PCCS, PCCS1, PCCS2, PCCS3, PCCS4)



TABLE 5 – METRIC

Bore Diameter Range mm		Piston Seal Groove Diameter	Seal Groove Height	Seal Cross Section	O-Ring Cross Section
Min	Max	D ₁ H8 mm	L (+200/-0) mm	C/S mm	OR mm
8	14.9	D - 4.9	2.2	2.45	1.78
15	39.9	D - 7.5	3.2	3.75	2.62
40	79.9	D - 11	4.2	5.5	3.53
80	132.9	D - 15.5	6.3	7.75	5.33
133	329.9	D - 21	8.1	10.5	6.99
330	669.9	D - 24.5	8.1	12.25	6.99
670	1,000	D - 28	9.5	14	8.40
1,000+	-	D - 28	9.5	14	8.40

TABLE 6 – INCH

Bore Diameter Range inch		Piston Seal Groove Diameter	Seal Groove Height	Seal Cross Section	O-Ring Cross Section
Min	Max	D ₁ H8 inch	L (+200/-0) inch	C/S inch	OR inch
0.118	0.311	D - .193	0.087	0.096	0.070
0.315	0.744	D - .295	0.126	0.148	0.103
0.748	1.492	D - .433	0.165	0.217	0.139
1.496	7.870	D - .610	0.248	0.305	0.210
7.874	10.075	D - .827	0.319	0.413	0.275
10.079	25.587	D - .965	0.319	0.482	0.275
25.591	39.366	D - 1.102	0.374	0.551	0.331
39.370 +	-	D - 1.102	0.374	0.551	0.331

Piston seal: Cross section (S) = (D-d)/2

Recommendations from Tables 7 and 8 can be applied to common industry applications for many double-acting piston seal incorporating bearing rings.

Double-Acting Piston Compression Seals with Bearing Rings (P20K4, P20K2P4, P20K5, P20K6)



TABLE 7 – METRIC

Bore Diameter Range mm		Piston Seal Groove Diameter	L-shaped Anti-extrusion Ring Leg Inner Diameter	Seal Groove Height	L-shaped Anti-Extrusion Ring Leg Height
Min	Max	D ₁ H9 mm	d ₆ f8 mm	L (+250/-0) mm	L ₄ mm
20	49.9	D - 10	D - 3	2.45	10.25
50	79.9	D - 15	D - 4	3.75	14
80	149.9	D - 20	D - 5	5.5	18
155	399.9	D - 25	D - 6	7.75	23
400	749.9	D - 30	D - 8	10.5	25
750	-	D - 40	D - 8	14	27

TABLE 8 – INCH

Bore Diameter Range inch		Piston Seal Groove Diameter	L-shaped Anti-extrusion Ring Leg Inner Diameter	Seal Groove Height	L-shaped Anti-Extrusion Ring Leg Height
Min	Max	D ₁ H9 inch	d ₆ f8 inch	L (+.01/-0) inch	L ₄ inch
0.787	1.965	D - .394	D - .118	0.096	0.404
1.969	3.146	D - .591	D - .157	0.148	0.551
3.150	5.902	D - .787	D - .197	0.217	0.709
6.102	15.744	D - .984	D - .236	0.305	0.906
15.748	29.524	D - 1.181	D - .315	0.413	0.984
29.528	-	D - 1.575	D - .315	0.551	1.063

Rod seal: Cross section (S) = (D₁-d)/2

Recommendations from Tables 9 and 10 can be applied to common industry applications for many single-acting rod V-Ring Sets.

Rod V-Ring Set (R28K, R28K1)



TABLE 9 – METRIC

Rod Diameter Range mm		Stuffing Box Bore	Working Stuffing Box Height	Seal Cross Section
Min	Max	D ₁ H9 mm	L ₃ (+250/-0) mm	C/S mm
10	39.9	d + 10	16	5
40	74.9	d + 15	25	7.5
75	149.9	d + 20	32	10
150	199.9	d + 25	40	12.5
200	300	d + 30	50	15
300	-	d + 40	64.5	20

TABLE 10 – INCH

Rod Diameter Range inch		Stuffing Box Bore	Working Stuffing Box Height	Seal Cross Section
Min	Max	D ₁ H9 inch	L ₃ (+250/-0) inch	C/S inch
0.394	1.571	d + .394	0.630	0.197
1.575	2.949	d + .591	0.984	0.295
2.953	5.902	d + .787	1.260	0.394
5.906	7.870	d + .984	1.575	0.492
7.874	11.811	d + 1.181	1.969	0.591
11.811	-	d + 1.575	2.539	0.787

For applications operating outside of typical industry conditions, it is strongly advised to consult Engineering to determine if these ranges are appropriate.

The listed dimensions are suggestions for standard housing dimensions only. Chesterton utilizes a machining process for manufacturing seal components that allows the flexibility to create any size based on equipment dimensions, as well as for non-standard housing.

Standard Fits and Tolerances Data Chart

Fits and Tolerances Based on ISO 286-1

ISO 286-1 International Standard is a geometrical product specification (GPS) standard. These ISO standard tolerance classes are used to define an acceptable size range in the manufacturing or reworking of equipment. The chart below shows generally accepted industry standards for hydraulic and pneumatic equipment. However, caution must be observed; these values may not pertain to all applications.

A tolerance class is combined with a basic size to determine the allowable range. For example, a 420 mm bore with a tolerance class of H9, i.e., 420 H9, would have a basic size and tolerance of 420 +155/-0 which equals 420.15 to 420.00 mm allowable range of size.

Consult with Chesterton Applications Engineering for suitability and use of this table.

Diameter Range Basic Size mm*(inch)		Tolerance (Rod based)	Tolerance (Rod based)	Tolerance (Rod based)	Tolerance (Rod based)	Tolerance (Rod based)	Tolerance (Rod based)	Tolerance (Hole based)	Tolerance (Hole based)	Tolerance (Hole based)	Tolerance (Hole based)	Tolerance (Hole based)
Over	Up-to (included)	f8	f11	h8	h9	h10	h11	F8	F11	H8	H9	H10
3 (0.118)	6 (0.236)	-10/-28 (-.0004/-.001)	-10/-85 (-.0004/-.003)	0/-18 (0/-.0007)	+0/-30 (+0/-.001)	0/-48 (0/-.002)	0/-75 (0/-.003)	+28/+10 (+.001/+.0004)	+85/+10 (+.003/+.0004)	+18/0 (+.0007/0)	+30/-0 (+.001/-0)	+48/0 (+.002/0)
6 (0.236)	10 (0.394)	-13/-35 (-.0005/-.001)	-13/-103 (-.0005/-.004)	0/-22 (0/-.001)	+0/-36 (+0/-.001)	0/-58 (0/-.002)	0/-90 (0/-.004)	+35/+13 (+.001/+.0005)	+103/+13 (+.004/+.0005)	+22/0 (+.001/0)	+36/-0 (+.0010/-0)	+58/0 (+.002/0)
10 (0.394)	18 (0.709)	-16/-43 (-.001/-.002)	-16/-126 (-.001/-.005)	0/-27 (0/-.001)	+0/-43 (+0/-.002)	0/-70 (0/-.003)	0/-110 (0/-.004)	+43/+16 (+.002/+.001)	+126/+16 (+.005/+.001)	+27/0 (+.001/0)	+43/-0 (+.002/-0)	+70/0 (+.003/0)
18 (0.709)	30 (1.181)	-20/-53 (-.001/-.002)	-20/-150 (-.001/-.006)	0/-33 (0/-.001)	+0/-52 (+0/-.002)	0/-84 (0/-.003)	0/-130 (0/-.005)	+53/+20 (+.002/+.001)	+150/+20 (+.006/+.001)	+33/0 (+.001/0)	+52/-0 (+.002/-0)	+84/0 (+.003/0)
30 (1.181)	50 (1.968)	-25/-64 (-.001/-.003)	-25/-185 (-.001/-.007)	0/-39 (0/-.002)	+0/-62 (+0/-.002)	0/-100 (0/-.004)	0/-160 (0/-.006)	+64/+25 (+.003/+.001)	+185/+25 (+.007/+.001)	+39/0 (+.001/0)	+62/-0 (+.002/-0)	+100/0 (+.004/0)
50 (1.968)	80 (3.15)	-30/-76 (-.001/-.003)	-30/-220 (-.001/-.009)	0/-46 (0/-.002)	+0/-74 (+0/-.003)	0/-120 (0/-.005)	0/-190 (0/-.007)	+76/+30 (+.003/+.001)	+220/+30 (+.009/+.001)	+46/0 (+.002/0)	+74/-0 (+.003/-0)	+120/0 (+.005/0)
80 (3.15)	120 (4.724)	-36/-90 (-.001/-.004)	-36/-256 (-.001/-.010)	0/-54 (0/-.002)	+0/-87 (+0/-.003)	0/-140 (0/-.006)	0/-220 (0/-.009)	+90/+36 (+.004/+.001)	+256/+36 (+.010/+.001)	+54/0 (+.002/0)	+87/-0 (+.003/-0)	+140/0 (+.006/0)
120 (4.724)	180 (7.086)	-43/-106 (-.002/-.004)	-43/-293 (-.002/-.011)	0/-63 (0/-.003)	+0/-100 (+0/-.004)	0/-160 (0/-.006)	0/-250 (0/-.010)	+106/+43 (+.004/+.002)	+293/+43 (+.011/+.002)	+63/0 (+.003/0)	+100/-0 (+.004/-0)	+160/0 (+.006/0)
180 (7.086)	250 (9.842)	-50/-122 (-.002/-.005)	-50/-340 (-.002/-.013)	0/-72 (0/-.003)	+0/-115 (+0/-.004)	0/-185 (0/-.007)	0/-290 (0/-.011)	+122/+50 (+.005/+.002)	+340/+50 (+.013/+.002)	+72/0 (+.003/0)	+115/-0 (+.004/-0)	+185/0 (+.007/0)
250 (9.842)	315 (12.401)	-56/-137 (-.002/-.005)	-56/-376 (-.002/-.015)	0/-81 (0/-.003)	+0/-130 (+0/-.005)	0/-210 (0/-.008)	0/-320 (0/-.012)	+137/+56 (+.005/+.002)	+376/+56 (+.015/+.002)	+81/0 (+.003/0)	+130/-0 (+.005/-0)	+210/0 (+.008/0)
315 (12.401)	400 (15.748)	-62/-151 (-.002/-.006)	-62/-422 (-.002/-.017)	0/-89 (0/-.004)	+0/-140 (+0/-.005)	0/-230 (0/-.009)	0/-360 (0/-.014)	+151/+62 (+.002/+.002)	+422/+62 (+.017/+.002)	+89/0 (+.004/0)	+140/-0 (+.005/-0)	+230/0 (+.009/0)
400 (15.748)	500 (19.685)	-68/-165 (-.003/-.007)	-68/-468 (-.003/-.018)	0/-97 (0/-.004)	+0/-155 (+0/-.006)	0/-250 (0/-.010)	0/-400 (0/-.016)	+165/+68 (+.007/+.003)	+468/+68 (+.018/+.003)	+97/0 (+.004/0)	+155/-0 (+.006/-0)	+250/0 (+.010/0)
500 (19.685)	630 (24.803)	-76/-186 (-.003/-.007)	-76/-516 (-.003/-.020)	0/-110 (0/-.004)	+0/-175 (+0/-.007)	0/-280 (0/-.011)	0/-440 (0/-.017)	+186/+76 (+.007/+.003)	+516/+76 (+.020/+.003)	+110/0 (+.004/0)	+175/-0 (+.007/-0)	+280/0 (+.011/0)
630 (24.803)	800 (31.496)	-80/-205 (-.003/-.008)	-80/-580 (-.003/-.023)	0/-125 (0/-.005)	+0/-200 (+0/-.008)	0/-320 (0/-.012)	0/-500 (0/-.019)	+205/+80 (+.008/+.003)	+580/+80 (+.023/+.003)	+125/0 (+.005/0)	+200/-0 (+.008/-0)	+320/0 (+.012/0)
800 (31.496)	1000 (39.37)	-86/-226 (-.003/-.009)	-86/-646 (-.003/-.025)	0/-140 (0/-.006)	+0/-230 (+0/-.009)	0/-360 (0/-.014)	0/-560 (0/-.022)	+226/+86 (+.009/+.003)	+646/+86 (+.025/+.003)	+140/0 (+.006/0)	+230/-0 (+.009/-0)	+360/0 (+.014/0)
1000 (39.37)	1250 (49.213)	-98/-263 (-.004/-.010)	-98/-758 (-.004/-.030)	0/-165 (0/-.007)	+0/-260 (+0/-.010)	0/-420 (0/-.016)	0/-660 (0/-.026)	+263/+98 (+.010/+.004)	+758/+98 (+.030/+.004)	+165/0 (+.007/0)	+260/-0 (+.010/-0)	+420/0 (+.016/0)
1250 (49.213)	1600 (62.992)	-110/-305 (-.004/-.012)	-110/-890 (-.004/-.035)	0/-195 (0/-.008)	+0/-310 (+0/-.012)	0/-500 (0/-.020)	0/-780 (0/-.031)	+305/+110 (+.012/+.004)	+890/+110 (+.035/+.004)	+195/0 (+.008/0)	+310/-0 (+.012/-0)	+500/0 (+.020/0)
1600 (62.992)	2000 (78.74)	-120/-350 (-.005/-.014)	-120/-1040 (-.005/-.041)	0/-230 (0/-.009)	+0/-370 (+0/-.015)	0/-600 (0/-.023)	0/-920 (0/-.036)	+350/+120 (+.014/+.005)	+1040/+120 (+.041/+.005)	+230/0 (+.009/0)	+370/-0 (+.015/-0)	+600/0 (+.023/0)

*mm tolerance values given in μm (.001 mm)

21K Wipers

Limits Contaminants from Entering System

Chesterton® positive rake wipers are designed to effectively clean and dislodge foreign matter from retracting rods or rams to minimize scoring and system contamination. The sharp, rugged, flared profile provides protection against abrasive particles which can contaminate the system and lead to premature equipment failure. These wipers provide excellent performance on rods or rams in hydraulic and pneumatic applications.

The 21K design is manufactured using a machining process which allows the flexibility to create any size based on equipment dimensions. This design incorporates a built-in static seal on the flange to ensure contaminants do not migrate along the stationary side of the wiper during operation. The 5K Super Wiper is made from a compression molding process that utilizes existing tooling.

Additional custom designs were developed to meet specific applications and equipment needs including snap-in, stepped, and bidirectional wipers.



- Single-acting, abrasion-resistant design for hydraulic and pneumatic applications
- Positive rake lip design effectively wipes contaminants away from surface
- Manufacturing process allows flexibility to create any size
- Sizes made to accommodate international standards including ISO and DIN

SPECIFICATIONS



Cap Material (designation)	Temperature °C (°F)	Speed m/s (ft/min)
AWC704 (FKM)	-30 to 200 (-20 to 400)	1.50 (300)
AWC800 (EU)	-50 to 85 (-60 to 185)	0.90 (185)
AWC825 (EU)	-50 to 85 (-60 to 185)	0.50 (100)
AWC830 (EU)	-35 to 75 (-30 to 165)	0.90 (185)
AWC860 (EU)	-50 to 120 (-60 to 250)	1.25 (250)

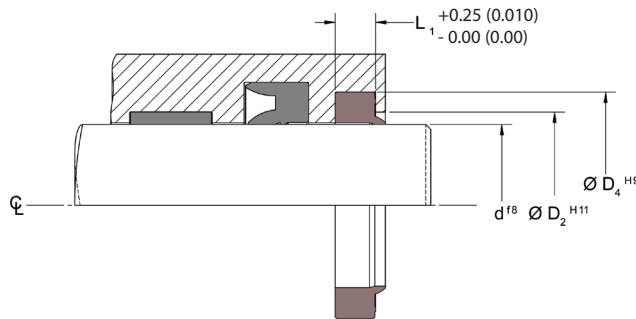

PRODUCT PROFILES



W21K



W21KF

ADDITIONAL PROFILES AVAILABLE IN COMPREHENSIVE PROFILE GUIDE

To place an order for Rod Wipers:

- Product profile: _____
 Material: _____
 Rod diameter (d): _____
 Housing diameter (D₂): _____
 Groove diameter (D₄): _____
 Groove height (L): _____

CW21K

Canned Wiper Seals

Protect the System from Entering Contaminants

Chesterton® positive rake wipers effectively clean and dislodge foreign matter from retracting rods or rams thus mitigating scoring and system contamination in open cavity designs. These wipers provide excellent performance for hydraulic applications.

Canned wiper seals require an open, easy construction, groove, and help to simplify gland design, layout, and manufacturing. An additional advantage is the possible space savings, as less space is required for canned wipers.

The CW21K is manufactured from a machining process which allows the flexibility to create any size based on equipment dimensions. The canned portion of the seal provides stability due to an interference fit that allows it to be pressed into an open cavity gland design.

These wipers are available in various material combinations based on equipment requirements, and the canned portion of the seal can be manufactured from metallic material and other engineered plastics.

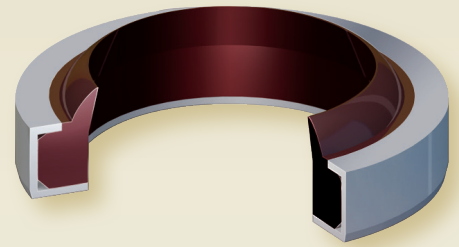

- Interference press-fit design does not require support of other external devices
- Space saving and easy, open construction groove
- Single-acting, abrasion-resistant design for hydraulic applications
- Positive rake lip design effectively wipes contaminants away from surface
- Manufacturing process allows flexibility to create any size

SPECIFICATIONS



Material (designation)	Temperature °C (°F)	Speed m/s (ft/min)
AWC704 (KFM)	-30 – 200 (-20 – 400)	1.50 (300)
AWC800 (EU)	-50 – 85 (-60 – 185)	1.00 (200)
AWC825 (EU)	-40 – 85 (-40 – 185)	0.50 (100)
AWC830 (EU)	-35 – 75 (-30 – 175)	0.90 (185)
AWC860 (EU)	-50 – 120 (-60 – 250)	1.25 (250)

Can material options: AWC650-POM, AWC663-PA6, AWC665-PA6+MoS2, Aluminum.

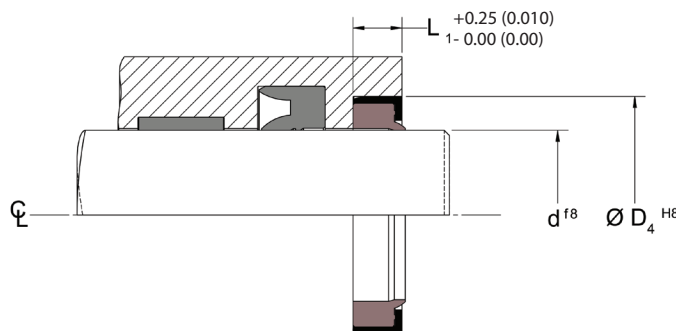

PRODUCT PROFILES



CW21K CW21K1 CW21K2 CW21K3

To place an order for Rod Wiper:

Product profile: _____

Material: _____

Rod or ram diameter (d): _____

Bore diameter (D₄): _____

Groove height (L₁): _____

22K

U-Cup Rod and Piston Seals

Special Geometry Provides Optimal Hydraulic Sealing

The Chesterton® 22K is a single-acting U-Cup design with a special seal lip geometry that provides zero leakage throughout the entire operating range.

The sturdy, static lip stabilizes the seal to minimize rolling, while the dynamic lip design minimizes issues associated with low-pressure sealing, provides additional stability, and eases installation. This seal design is offered as a rod or piston seal and provides excellent performance in hydraulic applications.

The 22K design is manufactured using a machining process which allows the flexibility to create any size based on equipment dimensions.

A number of additional designs have been derived from the original 22K design to address specific needs and applications in the market. These include the use of anti-extrusion rings for use in equipment with excessive clearances.

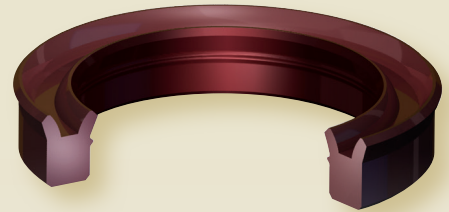

SPECIFICATIONS



Material (designation)	Temperature °C (°F)	Pressure MPa (psi)	Speed m/s (ft/min)
AWC704 (FKM)	-30 – 200 (-20 – 400)	35.0 (5000)	1.50 (300)
AWC800 (EU)	-50 – 85 (-60 – 185)	103.5 (15000)	1.00 (200)
AWC825 (EU)	-40 – 85 (-40 – 185)	52.0 (7500)	0.50 (100)
AWC830 (EU)	-35 – 75 (-30 – 175)	35.0 (5000)	1.00 (200)
AWC860 (EU)	-50 – 120 (-60 – 250)	103.5 (15000)	1.25 (250)

- Single-acting U-Cup design, zero leakage throughout the entire operating range
- Abrasion-resistant design, excellent performance in hydraulic applications
- Lip geometry, stabilizes seal to minimize rolling and eases installation
- Machining process allows the flexibility to create any size
- Sizes made to accommodate international standards including ISO and DIN

ROD APPLICATION

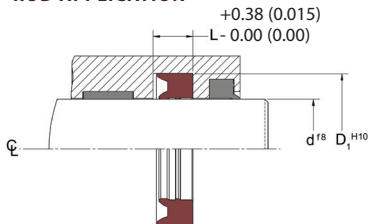

PISTON APPLICATION

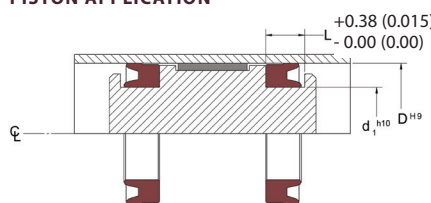

INSTALLED

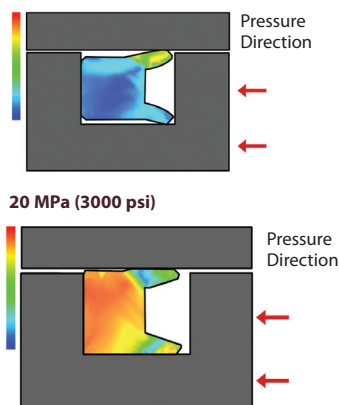

Figure 1. How the 22K performs installed and under pressure

To place an order for Rod Seal:

Product profile: _____
 Material: _____
 Rod or ram diameter (d): _____
 Bore diameter (D_i): _____
 Groove height (L): _____

To place an order for Piston Seal:

Product profile: _____
 Material: _____
 Piston groove diameter (d_i): _____
 Cylinder bore diameter (D): _____
 Groove height (L): _____

PRODUCT PROFILES



22KN

Rod and Piston Seals

Low Friction Design for Hydraulic and Pneumatic Sealing

The Chesterton® R22KN are single-acting, continuous U-Cup designs. The special lip design provides an optimal amount of radial sealing load with excellent tribological and sealing characteristics, resulting in minimal frictional resistance and low heat generation. The R22KN U-Cup reduces both breakaway force and dynamic frictional force during operation.

The optimum seal design facilitates controlled pressure distribution through the entire seal component, while the proper expansion space provides free space for deformation under pressure, optimizing seal contact area on the sliding surface.

The positive rake lip profile wipes contaminants away from the mating surface while in operation, thus prolonging seal and equipment service life. This seal design is offered as a rod, piston, and face seal and provides outstanding performance in light- to heavy-duty hydraulic and pneumatic applications.

The 22KN design is manufactured using a machining process that allows the flexibility to create any size based on equipment dimensions. A number of unique designs have been derived from the original R22KN to address specific needs and applications in the market. These include designs to address pressure reversal, pressure spikes, and system vacuuming.

SPECIFICATIONS



Material (designation)	Temperature °C (°F)	Pressure MPa (psi)	Speed m/s (ft/min)
AWC704 (FKM)	-30 – 200 (-20 – 400)	16.0 (2320)	1.50 (300)
AWC800 (EU)	-50 – 85 (-60 – 185)	103.5 (15000)	1.00 (200)
AWC825 (EU)	-40 – 85 (-40 – 185)	52.0 (7500)	0.50 (100)
AWC830 (EU)	-35 – 75 (-30 – 175)	52.0 (7500)	0.90 (185)
AWC860 (EU)	-50–120 (-60 – 250)	103.5 (15000)	1.25 (250)

PISTON APPLICATION

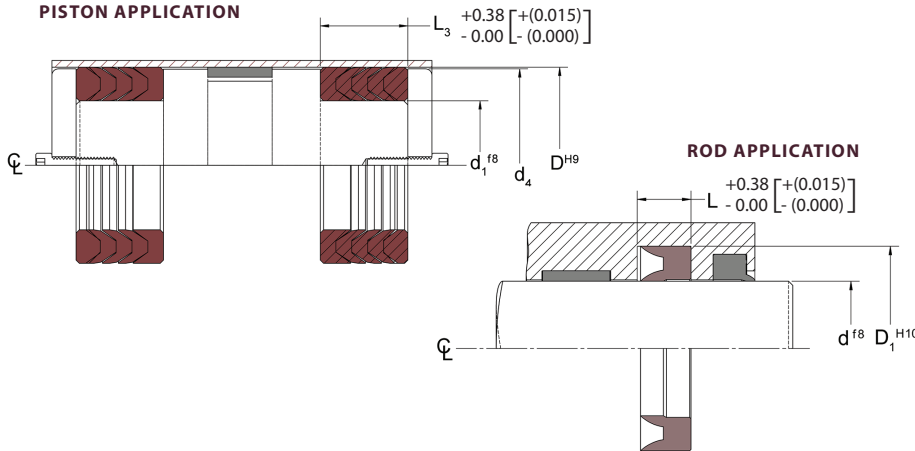

PRODUCT PROFILES

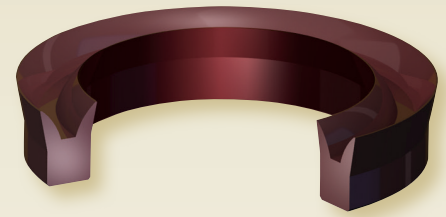

- Single-acting U-Cup design minimizes frictional resistance and breakaway force
- Positive rake lip design wipes contaminants away from mating surface
- Abrasion-resistant design; outstanding performance in hydraulic and pneumatic applications
- Manufacturing process allows flexibility to create any size
- Sizes made to accommodate international standards including ISO

To place an order for Rod Seal:

Product profile: _____
 Material: _____
 Rod or ram diameter (d): _____
 Bore diameter (D): _____
 Groove height (L): _____

To place an order for Piston Seal:

Product profile: _____
 Material: _____
 Piston groove diameter (d): _____
 Piston groove diameter (d): _____
 Cylinder bore diameter (D): _____
 Groove height (L): _____

22KE

Rod and Piston Seals

Energized Dual Component for Added Stability

The Chesterton® 22KE is a single-acting, continuous U-Cup design, which incorporates the use of an O-Ring to increase pre-load capabilities. The O-Ring energizes the seal in the absence of system pressure and provides stability at higher temperatures. This seal design is offered as a rod or piston seal and provides excellent performance in hydraulic applications.

The 22KE design is manufactured using a machining process that allows the flexibility to create any size based on equipment dimensions. The special seal lip geometry provides an optimal pre-load to maximize performance, and the negative rake design eases installation.

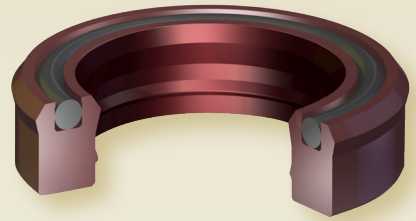

SPECIFICATIONS



Material (designation)	Temperature °C (°F)	Pressure MPa (psi)	Speed m/s (ft/min)
AWC704 (FKM)	-30 – 200 (-20 – 400)	35.0 (5000)	1.50 (300)
AWC800 (EU)	-50 – 85 (-60 – 185)	103.5 (15000)	0.90 (185)
AWC825 (EU)	-40 – 85 (-40 – 185)	52.0 (7500)	0.50 (100)
AWC830 (EU)	-35 – 75 (-30 – 165)	35.0 (5000)	0.90 (185)
AWC860 (EU)	-50 – 120 (-60 – 250)	103.5 (15000)	1.25 (250)

O-Ring material is FKM

- Single-acting U-cup design, zero leakage throughout the entire operating range
- O-Ring loader energizes seal and provides stability at higher pressures
- Abrasion-resistant design, excellent performance in hydraulic applications
- Lip geometry stabilizes seal to minimize rolling and eases installation
- Machining process allows the flexibility to create any size

PISTON APPLICATION

ROD APPLICATION

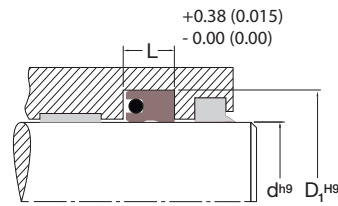
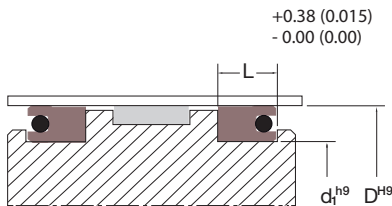

PRODUCT PROFILES

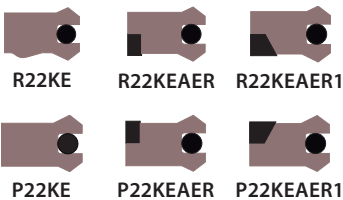

To place an order for Rod Seal:

Product profile: _____
 Material: _____
 Rod or ram diameter (d): _____
 Bore diameter (D₁): _____
 Groove height (L): _____

To place an order for Piston Seal:

Product profile: _____
 Material: _____
 Piston groove diameter (d₁): _____
 Cylinder bore diameter (D): _____
 Groove height (L): _____

20K

Rod and Piston Seals

Heavy-duty, Bidirectional, Low-speed Hydraulic Sealing

The Chesterton® 20K Duoseal is a continuous, bi-directional compression seal with dual independent sealing points. The robust, durable, dual lip profile was specifically designed for single groove cavities in heavy duty, high pressure, hydraulic applications.

The 20K Duoseals are made from our unique machining process which minimizes the need for tooling costs associated with new sizes. The heavy duty seal design has the ability to withstand pressure spikes while helping to reduce the effects of side loading.

Additional designs were developed to meet specific application and equipment needs including the incorporation of various anti-extrusion devices for combating excessive clearances and pressure spikes.

SPECIFICATIONS



Material (designation)	Temperature °C (°F)	Pressure MPa (psi)	Speed m/s (ft/min)
AWC704 (FKM)	-30 – 200 (-20 – 400)	35.0 (5000)	0.75 (150)
AWC800 (EU)	-50 – 85 (-60 – 185)	103.5 (15000)	0.50 (100)
AWC825 (EU)	-40 – 85 (-40 – 185)	52.0 (7500)	0.50 (100)
AWC830 (EU)	-35 – 75 (-30 – 175)	345.0 (5000)	0.50 (100)
AWC860 (EU)	-50 – 120 (-60 – 250)	103.5 (15000)	0.62 (125)

PISTON APPLICATION

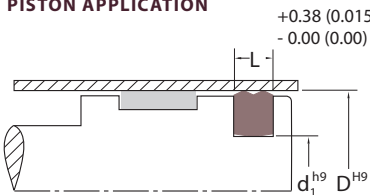

ROD APPLICATION

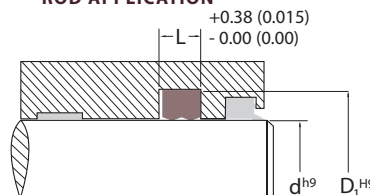

PRODUCT PROFILES



R20K1



P20K1

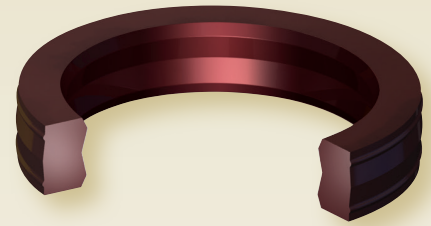

- Double acting, high pressure, hydraulic applications >35 bar (500 psi)
- Ideal replacement for 2, 3, or 4 piece cap seal assemblies
- Unique manufacturing process allows the flexibility to create any size
- Sizes made to accommodate international standards including ISO and DIN

To place an order for Rod Seal:

Product profile: _____
 Material: _____
 Rod or ram diameter (d): _____
 Bore diameter (D₁): _____
 Groove height (L): _____

To place an order for Piston Seal:

Product profile: _____
 Material: _____
 Piston groove diameter (d₁): _____
 Cylinder bore diameter (D): _____
 Groove height (L): _____

23K

Pneumatic U-Cup Rod and Piston Seals

Optimum Geometry for Pneumatic Sealing

The Chesterton® 23K seal is a single-acting, U-cup design that incorporates a unique, dynamic lip geometry that provides the optimal sealing force required for low pressure pneumatic applications.

The 23K design is manufactured using a machining process which allows the flexibility to create any size based on equipment dimensions. The radiused lip design ensures a continuous lubricating film is maintained which minimizes operating temperature and wear delivering excellent sealing performance.



- Unique lip geometry provides optimal sealing force for pneumatic applications
- Radiused lip design ensures a continuous lubricating film, minimizing wear
- Machining process allows the flexibility to create any size
- Sizes made to accommodate international standards including ISO and DIN

SPECIFICATIONS



Material (designation)	Temperature °C (°F)	Pressure MPa (psi)	Speed m/s (ft/min)
AWC704 (FKM)	-30 – 200 (-20 – 400)	0.9 (125)	1.50 (300)
AWC800 (EU)	-50 – 85 (-60 – 185)		0.90 (185)
AWC825 (EU)	-40 – 85 (-40 – 185)		0.50 (100)
AWC830 (EU)	-35 – 75 (-30 – 165)		0.90 (185)
AWC860 (EU)	-50 – 120 (-60 – 250)		1.25 (250)

PISTON APPLICATION

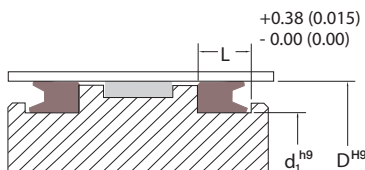

ROD APPLICATION

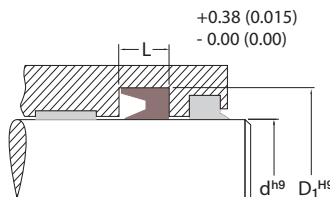

To place an order for Rod Seal:

Product profile: _____
 Material: _____
 Rod or ram diameter (d): _____
 Bore diameter (D₁): _____
 Groove height (L): _____

PRODUCT PROFILES



To place an order for Piston Seal:

Product profile: _____
 Material: _____
 Piston groove diameter (d₁): _____
 Cylinder bore diameter (D): _____
 Groove height (L): _____

CCS

Custom Cap Seals, Rod and Piston Dual Component System for Bi-directional Sealing

The Chesterton® Custom Cap Seals (CCS) are custom manufactured, rod or piston mounted, bi-directional seals made from second generation PTFE. The second generation PTFE offers improved performance over conventional materials. Each seal is individually manufactured and provides excellent performance in single groove, double acting, hydraulic applications.

Each cap seal is made from our machining process which minimizes the need for tooling costs associated with new sizes. This cap seal design is comprised of a two-piece, sealing system that uses an elastomeric cap with an O-Ring to create a very effective seal. The cap is used as the dynamic sealing element while the O-Ring energizes the cap and creates a static seal.

Additional designs were developed to meet specific application and equipment needs. Both components are available in a range of engineered materials to best suit the specific operating requirements.

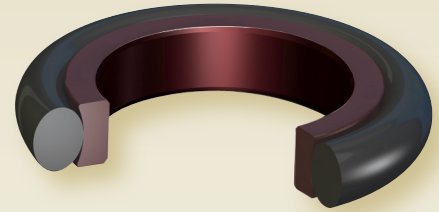

- Second generation PTFE offers improved performance
- Compression seal design increases sealing force with system pressure
- Proven seal design provides predictable performance
- Sizes made to accommodate international standards including ISO and DIN

SPECIFICATIONS



Cap Material (designation)	Temperature °C (°F)	Pressure MPa (psi)	Speed m/s (ft/min)
*AWC300	-35 – 120 (-30 – 250)	35 (5000)	15.00 (3000)
*AWC800 (EU)	-35 – 85 (-30 – 185)		0.85 (185)
*AWC860 (EU)	-35 – 120 (-30 – 250)		1.25 (250)
**AWC400 (1% graphite, 10% carbon filled PTFE)	-35 – 120 (-30 – 250)		15.00 (3000)
**AWC500 (40% bronze filled PTFE)	-35 – 120 (-30 – 250)		15.00 (3000)

*Buna energizer
**FKM energizer

PISTON APPLICATION

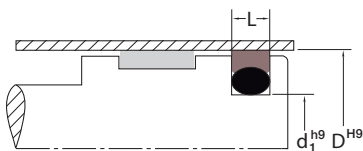

ROD APPLICATION

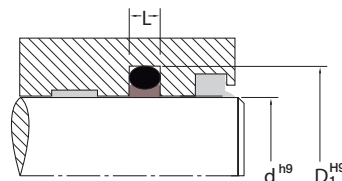

PRODUCT PROFILES



To place an order for Rod Seal:

Product profile: _____
 Material: _____
 Rod or ram diameter (d): _____
 Bore diameter (D): _____
 Groove height (L): _____

To place an order for Piston Seal:

Product profile: _____
 Material: _____
 Piston groove diameter (d₁): _____
 Cylinder bore diameter (D): _____
 Groove height (L): _____

P7K

Piston Seals

Piston Cup with Rigid Base for Hydraulic and Pneumatic Sealing

The Chesterton® 7K is a single-acting piston cup with a positive flared lip design to optimize dynamic sealing forces. Reduced frictional force and low heat generation result in low wear, which prolongs seal and cylinder service life and reliability. The seal is responsive to low-pressure fluctuations, thus optimizing the sealing effect in most operating conditions. The rugged construction is the ideal replacement to upgrade from traditional rubber-based seals for use in light- to medium-duty hydraulic or pneumatic applications.

High performance thermoset polyurethane materials provide superior wear resistance and excellent memory retaining lip flare.

The 7K is manufactured from a custom compression molding process with a supporting brass disc molded into the base. The resulting rigid base provides a stable, non-distorting, anti-extrusion resistant seal, and the center hole can be custom sized to meet your equipment-specific needs.

The 7K1 is polyurethane throughout and is manufactured using a machining process that allows the flexibility to create any size based on equipment dimensions.

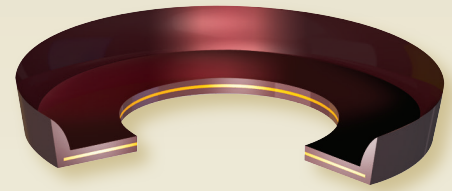

- Positive flared lip design optimizes sealing forces
- Supporting metallic brass disc improves seal performance
- Long-life cup resists swelling, deformation, drag, and binding
- Custom sized center hole makes seal retrofit

SPECIFICATIONS



Material (designation)	Temperature °C (°F)	Pressure MPa (psi)	Speed m/s (ft/min)
AWC704 (FKM)	-30 – 200 (-20 – 400)	16.0 (2300)	1.50 (300)
AWC800 (EU)	-50 – 85 (-60 – 185)	16.0 (2300)	1.00 (200)
AWC825 (EU)	-40 – 85 (-40 – 185)	16.0 (2300)	0.50 (100)
AWC830 (EU)	-35 – 75 (-30 – 175)	16.0 (2300)	0.90 (185)
AWC860 (EU)	-50 – 120 (-60 – 250)	16.0 (2300)	1.25 (250)

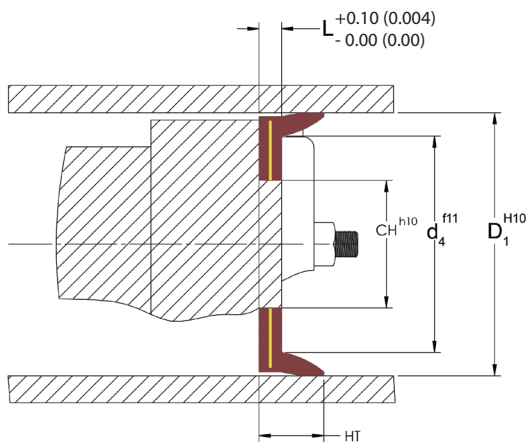

PRODUCT PROFILES



P7K



P7K1

To place an order for Piston Seal:

Product profile: _____

Material: _____

Piston groove diameter (d₄): _____

Cylinder bore diameter (D₁): _____

Seal height (HT): _____

Groove height (L): _____

9K

Anti-extrusion Rings

Minimize Extrusion of Dynamic and Static Seals

Chesterton® 9K Anti-Extrusion Rings, often referred to as back-up rings, have no intended sealing function. 9K provides protection to pressurized dynamic and static seals (including O-Rings) from extruding into equipment clearances while under pressure, thus protecting seal components from premature failure and prolonging their service life. Protection is provided by tight fit of the anti-extrusion rings in the seal groove to minimize the extrusion gap.

9K anti-extrusion rings are recommended to use when:

- Hydraulic system pressure exceeds the seal’s extrusion resistance limitation
- Fluid pressure spikes exceed the normal system pressure
- The system temperature is high enough to lower the extrusion resistance of the seal
- The use of nonmetallic bearing bands increases the radial clearance and extrusion gap

9K anti-extrusion rings are available in various extrusion-resistant materials and custom profiles. Split design options are available for ease of installation.

Each ring is individually manufactured and provides excellent performance, as a supporting element to piston, rod, and face seals that are generally found in static or dynamic applications.

SPECIFICATIONS

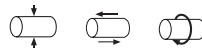

Material (designation)	Temperature °C (°F)
AWC650 (Acetal)	-30 – 90 (-20 – 200)
AWC665 (Nylon with MoS ₂)	-40 – 105 (-40 – 212)
AWC800 (EU)	-50 – 85 (-60 – 185)
AWC860 (EU)	-50 – 120 (-60 – 250)
AWC300 (Glass-Filled PTFE)	-35 – 175 (-30 – 350)
AWC400 (Carbon-Filled PTFE)	-35 – 175 (-30 – 350)
AWC500 (Bronze-Filled PTFE)	-35 – 175 (-30 – 350)
AWC520 (Virgin PTFE)	-35 – 175 (-30 – 350)
AWC630 (Unfilled PEEK)	-45 – 175 (-50 – 350)

PISTON APPLICATION

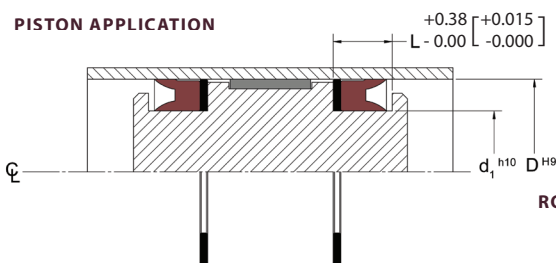

ROD APPLICATION

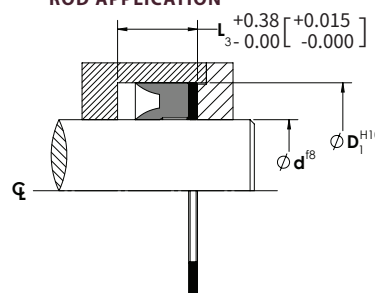

PRODUCT PROFILES



9K



- Provide protection against extrusion of sealing elements into equipment clearances; improve MTBR
- Improve high-pressure handling capability of the seals
- Static and dynamic applications; plant-wide usage
- Machining process allows the flexibility to create any size
- Available in various profiles and materials

To place an order for Rod AER:

Product profile: _____
 Material: _____
 Rod or ram diameter (d): _____
 Bore diameter (D): _____
 Groove height (L): _____

To place an order Piston AER:

Product profile: _____
 Material: _____
 Piston groove diameter (d₁): _____
 Cylinder bore diameter (D): _____
 Groove height (L): _____

18K/19K

Bearing Bands

High Performance, Replaceable Wear Rings for Cylinders

Chesterton® replaceable Bearing Bands are the solution to costly cylinder re-machining and repairs for hydraulic or pneumatic equipment. These split, replaceable bearing bands minimize metal-to-metal contact of moving parts and help prolong equipment life. When installed during the cylinder repair, the risk of recurring damage is significantly reduced.

The easy-to-use split 18K and 19K designs are manufactured from a glass fiber reinforced thermoplastic polyimide resin (heat stabilized nylon). These bearings reduce radial movement, helping to extend seal life. These designs are suitable for use on rods, rams, or pistons in reciprocating, rotary, or static applications due to their exceptional physical properties and built-in lubricants.

SPECIFICATIONS

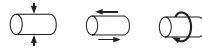

Material (designation)	Temperature °C (°F)	Compressive Strength MPa (psi) ASTM D965	Permissible Compressive Load MPa (psi)	Speed m/sec (ft/min)
AWC660 40% (Glass-Filled Nylon)	-40 – 121 (-40 – 250)	158.6 (23000)	55.0 (7975)	1.25 (250)

18K INCH DESIGN

Cross Section (S) mm	Height (L ₂) mm	Diameter Range (d/D) mm
0.125	0.375	1.0 – 4
	0.500	1.5 – 6
	0.750	3.5 – 8
	1.000	4.0 – 20

19K METRIC DESIGN

Cross Section (S) mm	Height (L ₂) mm	Diameter Range (d/D) mm
2.5	5.00	20.0 – 140
	9.00	55.0 – 220
	14.00	70.0 – 400
	24.00	315.0 – 400

PISTON APPLICATION

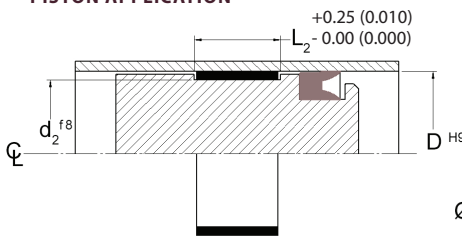

ROD APPLICATION

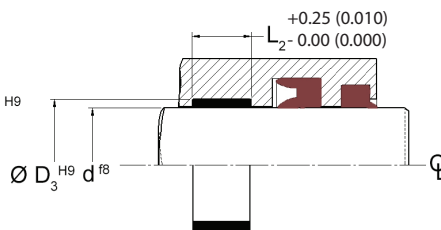

PRODUCT PROFILES

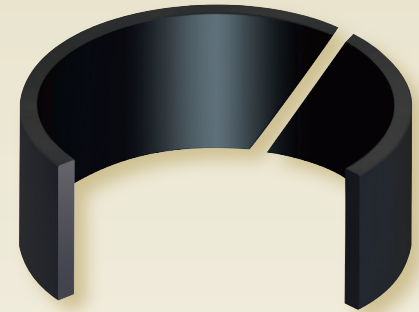

- Heat stabilized nylon, same carrying load yet less expensive than bronze
- Replaceable bearings minimize metal-to-metal scoring and prolong equipment life
- Reduce radial movement, extending seal life
- Retrofit existing bearing grooves and eliminate unnecessary modifications
- Split design minimizes downtime

To place an order for Rod Bearing:

Product profile: _____
 Material: _____
 Rod or ram diameter (d): _____
 Groove diameter (D₃): _____
 Groove height (L₂): _____

To place an order for Piston Bearing:

Product profile: _____
 Material: _____
 Groove diameter (d₂): _____
 Cylinder bore diameter (D): _____
 Groove height (L₂): _____

16K/17K

Bearing Band Strips

High Performance Replaceable Bearing Strips for Presses

Chesterton® 16K (metric) and 17K (inch) replaceable Bearing Band Strips are the solution to costly cylinder re-machining and repairs for large diameter hydraulic or pneumatic equipment. These split, replaceable bearings minimize metal-to-metal scoring and reduce radial movement, extending seal and equipment life.

The split, continuous coil designs are made from a combination of composite polyester resin reinforced with synthetic fibers specifically designed to support heavy loads. These designs are suitable for use on rams and pistons in reciprocating applications due to their exceptional physical properties and built-in lubricants.

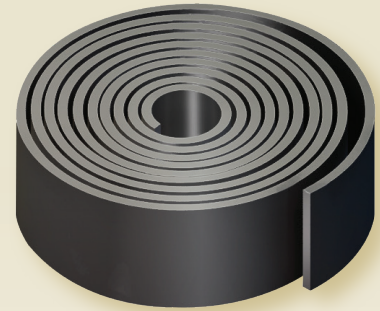

- Minimize metal-to-metal scoring, help prolong equipment life
- Reduce radial movement, extend seal life
- Built-in lubricant for lower coefficient of friction between mating surfaces
- Split continuous coil accommodates large diameter equipment

SPECIFICATIONS



Material (designation)	Temperature °C (°F)	Compressive Strength MPa (psi) ASTM D695	Permissible Compressive Load MPa (psi)	Speed m/sec (ft/min)
AWC640 (Thermoset Polyester Resin)	-40 – 121 (-40 – 250)	345.0 (50000)	100.0 (14500)*	1.00 (200)

*At 20°C (68°F)

PISTON APPLICATION

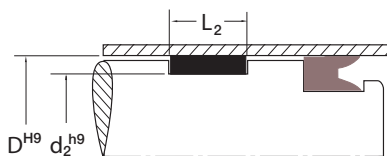

ROD APPLICATION

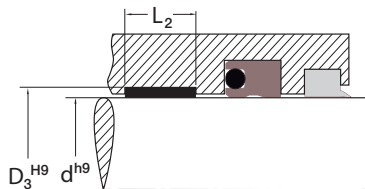

PRODUCT PROFILES



16K

17K

To place an order for Rod Bearing:

Product profile: _____
 Material: _____
 Rod or ram diameter (d): _____
 Groove diameter (D₃): _____
 Groove height (L₂): _____

To place an order for Piston Bearing:

Product profile: _____
 Material: _____
 Groove diameter (d₂): _____
 Cylinder bore diameter (D): _____
 Groove height (L₂): _____

16K/17K

Bearing Band Strips

Cut to Fit

The precise manufacturing technology of the 16K and 17K Wear Ring Strips provides accurate dimensional and geometrical tolerances and improved fitting. According to industrial standards sizing, the 16K and 17K are a direct retrofit to existing bearing grooves, which minimizes equipment modification.

Universal Use in Reciprocating Applications

The split design of this product makes the installation of the cut rings easy (snap-in fitting). This allows the product to be used universally on rods, rams, or pistons in reciprocating applications for rotary or static applications.

16K METRIC DESIGN

Cross Section (S) mm	Height (L ₂) mm	Diameter Range (d/D) mm
2.50 – 4.00	15.000	300 – 1575
	20.000	300 – 1575
	25.000	300 – 1575
	30.000	300 – 1575

Applicable standards: ISO 10766

17K INCH DESIGN

Cross Section (S) inch	Height (L ₂) inch	Diameter Range (d/D) inch
0.125	0.375	12 – 62
	0.500	12 – 62
	0.625	12 – 62
	0.750	12 – 62
	1.000	12 – 62
	1.500	12 – 62
	2.000	12 – 62

AWC640 PV (PRESSURE-VELOCITY) CHART

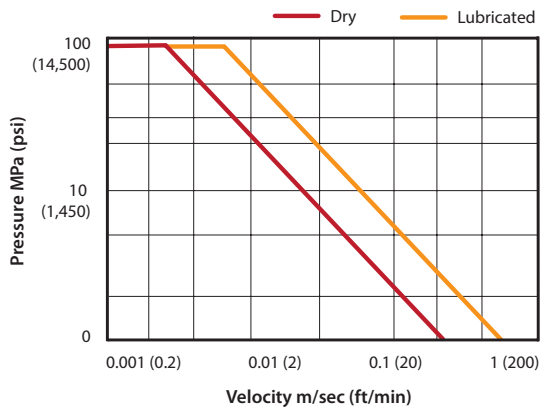

AWC640 LOAD-TEMPERATURE CAPACITY CHART

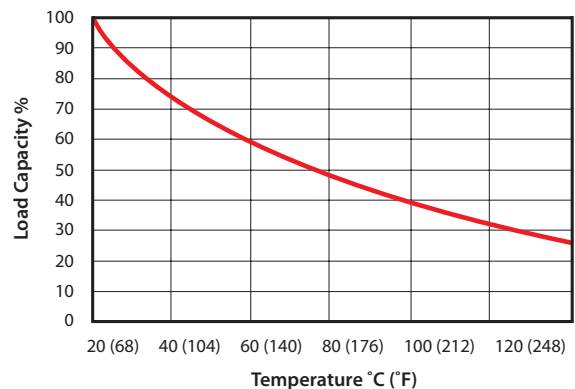

WR

Custom Wear Rings

Custom Replacement Bearing Bands

Chesterton® Custom Wear Rings (WR) are the solution to costly cylinder re-machining and repairs for pneumatic and light- to heavy-duty hydraulic equipment. These split, replaceable wear rings reduce the probability of metal-to-metal contact of moving parts and help prolong equipment life. When installed during the cylinder repair, the risk of recurring damage is significantly reduced.

The easy-to-use, split WR designs are manufactured from various engineered plastic materials to provide the best possible bearing solution based on operating conditions and hardware configuration. Utilized plastic compounds have good bearing capacity and are capable of supporting transverse loads. These bearings reduce radial movement, helping to extend seal life.

The use of nonmetallic wear rings helps to minimize the buildup of hydrodynamic pressure in small clearances of the cylinders and can also help to minimize the diesel effect. Each seal is individually manufactured from our unique machining process that minimizes the need for tooling costs associated with new sizes.

The precise CNC lathe manufacturing technology of the WR provides accurate dimensional and geometrical tolerances, and improved fitting. Flexible manufacturing technology allows for the production of virtually any size and shape, thus providing retrofit bearing solutions.

Various designs and materials are available including the WR, P9KL, R9KL, WRTP, WRTR, WRUP, and WRUR, which address specific needs and applications in the market.

SPECIFICATIONS

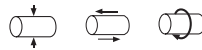

Material (designation)	Temperature °C (°F)	Compressive Strength MPa (psi) ASTM/ISO Testing	Permissible Compressive Load MPa (psi)	Speed m/sec (ft/min)
AWC650 (Acetal)	-30 – 90 (-20 – 200)	55.2 (8000)	20.0 (2900)	3.00 (600)
AWC663 (Nylon)	-40 – 105 (-40 – 212)	90.0 (13050)	30.0 (4500)	3.00 (600)
AWC665 (Nylon with MoS ₂)	-40 – 105 (-40 – 212)	96.7 (14000)	30.0 (4500)	3.00 (600)
AWC300 (Glass-Filled PTFE)	-35 – 120 (-30 – 250)	10.6 (1540)	3.5 (510)	5.00 (1000)
AWC400 (Carbon-Filled PTFE)	-35 – 120 (-30 – 250)	8.5 (1230)	2.5 (365)	5.00 (1000)
AWC500 (Bronze-Filled PTFE)	-35 – 120 (-30 – 250)	10.1 (1540)	4.5 (652)	5.00 (1000)
AWC520 (Virgin PTFE)	-35 – 120 (-30 – 250)	7.9 (1145)	2.5 (365)	5.00 (1000)
AWC630 (Unfilled PEEK)	-45 – 175 (-50 – 350)	138.1 (20000)	-	1.00 (200)
AWC635 (Glass-Filled PEEK)	-45 – 175 (-50 – 350)	179.5 (26000)	-	1.00 (200)

PISTON APPLICATION

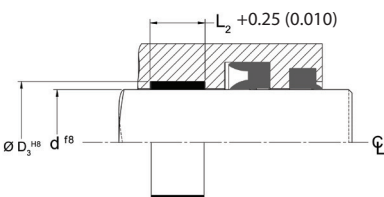

ROD APPLICATION

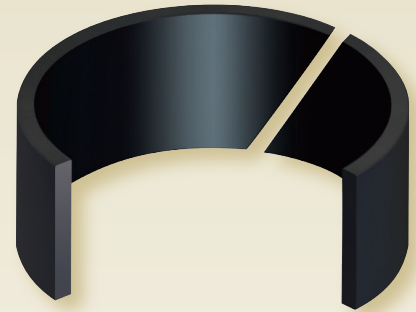
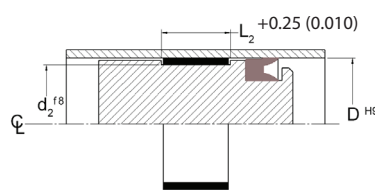

- Cost-effective method for improving equipment performance
- Reduce radial movement; diminish probability of metal-to-metal contact while extending seal life
- Custom Wear Rings eliminate unnecessary modifications
- Reduce probability of buildup of hydrodynamic pressure, thus prolonging seal life
- Machining process allows the flexibility to create any size

To place an order for Rod Bearing/WR:

Product profile: _____
 Material: _____
 Rod or ram diameter (d₂): _____
 Groove diameter (D): _____
 Groove height (L₂): _____

To place an order for Piston Bearing/WR:

Product profile: _____
 Material: _____
 Groove diameter (d): _____
 Cylinder bore diameter (D₃): _____
 Groove height (L₂): _____

WR

Custom Wear Rings

PRODUCT PROFILES



WR R9KL WRTR WRUR P9KL WRTP WRUP

PTFE-BRONZE PV (PRESSURE-VELOCITY) CHART

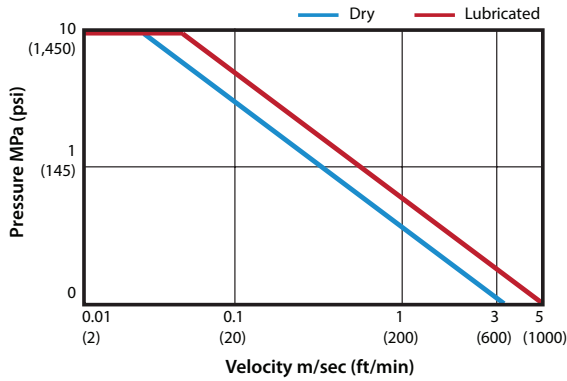

PTFE-BRONZE LOAD-TEMPERATURE CAPACITY CHART

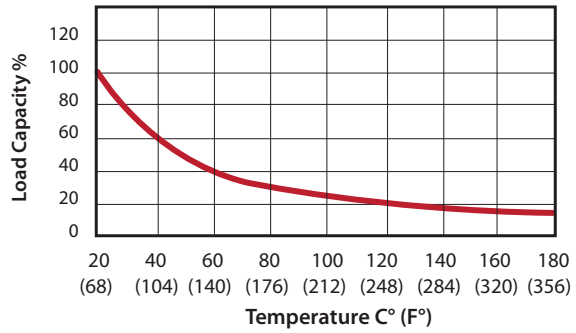

NYLON PA6 PV (PRESSURE-VELOCITY) CHART

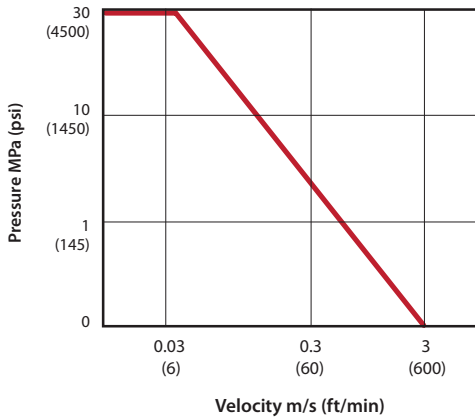

NYLON PA6 LOAD-TEMPERATURE CAPACITY CHART

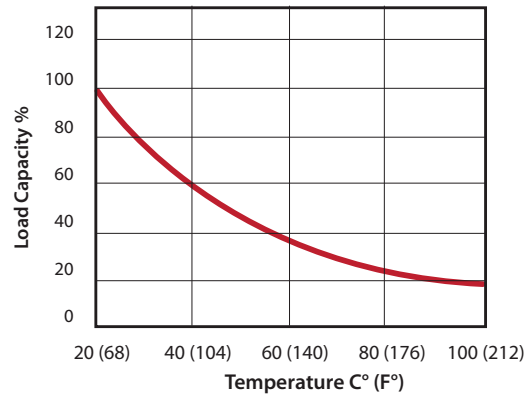

POLY-ACETAL PV (PRESSURE-VELOCITY) CHART

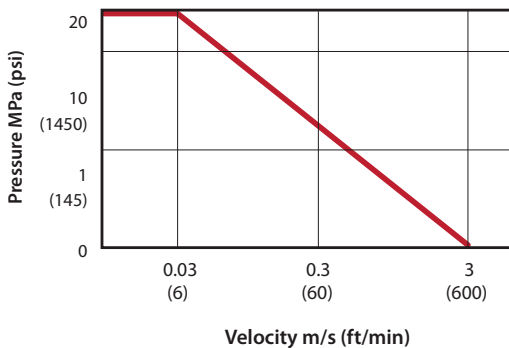

POLY-ACETAL LOAD-TEMPERATURE CAPACITY CHART

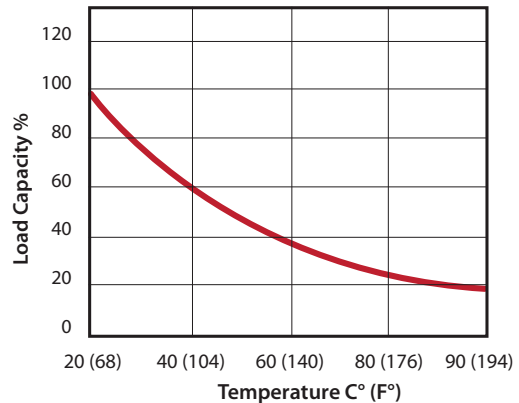

R600

Rod Seals

Gland-sensitive, Stacked Set for Older, Worn Equipment

The Chesterton® 600 is a single-acting, stacked V-Ring set that enables the gland force transfer pressure to ensure each ring loads evenly. The 600 series is used in heavy-duty, hydraulic applications, offering outstanding performance and long service life under difficult operating conditions, such as misalignment or pressure peaks. The seal assembly consists of a male adapter and seal rings. The special seal ring design makes the female adapter unnecessary, helping to reduce friction generation.

The rugged, rubber-based construction is ideal for older, worn equipment, since it conforms to surface irregularities to effectively control leakage. This seal set provides outstanding performance in hydraulic cylinders or presses, due to its material strength and durability. The surface of the seal has pockets that retain hydraulic fluid for lubrication on the dynamic surface, thus reducing friction and wear.

This design is particularly adaptable to deep stuffing boxes and unconventional ram sizes, where equipment cannot be disassembled.

The 600 is traditionally a compression molded, stacked seal set, which utilizes tooling to create a final product. The sets are available in split or continuous configurations.

Each seal ring is individually manufactured with a flat landing to ensure gland load is transferred through the set upon tightening. A male bottom adapter is designed to provide even loading, centering, and support.

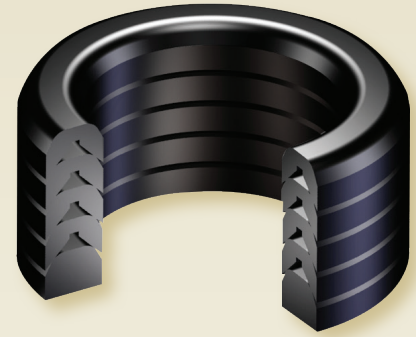

- Rubber-based materials conform to surface imperfections to control leakage
- Misalignment and pressure peak handling capabilities
- Neoprene-based materials perform well in water and oil
- Butyl-based materials perform well in phosphate ester fluids
- Split design eases installation and reduces installation time

SPECIFICATIONS



Material (designation)	Temperature °C (°F)	Pressure MPa (psi)	Speed m/s (ft/min)
AWC735 Neoprene (NR)	-25 – 121(-13 – 250)	34.5 (5000)	0.6 (120)
AWC747 Butyl (IIR)	-25 – 121(-13 – 250)	34.5 (5000)	0.6 (120)

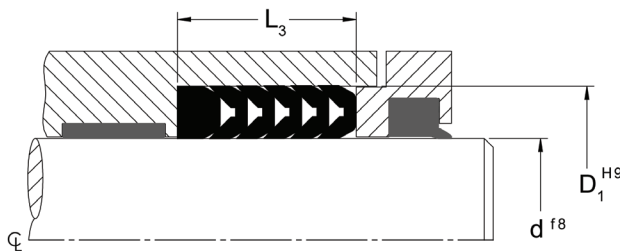

PRODUCT PROFILES



R600

To place an order Rod Seal:

Product profile: _____

Material: _____

Rod or ram diameter (d): _____

Bore diameter (D₁): _____

Working height (L₃): _____

R600

Rod Seals

RECOMMENDED NUMBER OF SEAL RINGS AND ADAPTER REQUIRED BASED ON PRESSURE

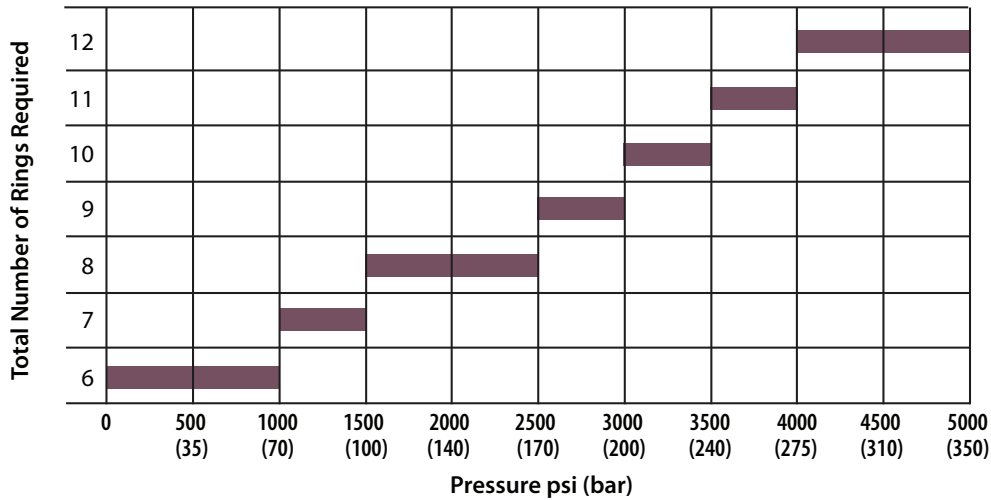

Note: For pressure 3000 psi (200 bar) and above we suggest the use of an anti-extrusion ring.

600 STACKED V-RING APPROXIMATE FREE STACK HEIGHT CHART

Stack height per set, including one bottom ring rounded down to the nearest 1/16 inch (1.6mm) per inch of depth

Number of Rings	4 Rings	5 Rings	6 Rings	7 Rings	8 Rings	9 Rings	10 Rings	11 Rings	12 Rings
Cross Section mm (inch)	mm (inch)	mm (inch)	mm (inch)	mm (inch)	mm (inch)	mm (inch)	mm (inch)	mm (inch)	mm (inch)
4.75 (0.187)	17.45 (0.687)	22.23 (0.875)	25.40 (1.000)	30.15 (1.187)	34.93 (1.375)	39.70 (1.563)	42.88 (1.688)	47.63 (1.875)	52.40 (2.063)
6.35 (0.250)	20.62 (0.812)	41.28 (1.625)	31.75 (1.250)	36.50 (1.437)	41.28 (1.625)	47.63 (1.875)	52.40 (2.063)	57.15 (2.250)	61.93 (2.438)
7.92 (0.312)	25.40 (1.000)	31.75 (1.250)	36.50 (1.437)	42.85 (1.687)	49.23 (1.938)	55.58 (2.188)	60.33 (2.375)	66.68 (2.625)	73.02 (2.875)
9.53 (0.375)	25.40 (1.000)	31.75 (1.250)	36.50 (1.437)	42.85 (1.687)	49.23 (1.938)	55.58 (2.188)	60.33 (2.375)	66.68 (2.625)	73.02 (2.875)
11.10 (0.437)	28.58 (1.125)	34.93 (1.375)	41.28 (1.625)	49.20 (1.937)	55.58 (2.188)	61.93 (2.438)	68.28 (2.688)	76.20 (3.000)	82.55 (3.250)
12.70 (0.500)	28.58 (1.125)	34.93 (1.375)	41.28 (1.625)	49.20 (1.937)	55.58 (2.188)	61.93 (2.438)	68.28 (2.688)	76.20 (3.000)	82.55 (3.250)
14.27 (0.562)	31.75 (1.250)	39.67 (1.562)	47.63 (1.875)	55.58 (2.188)	61.93 (2.438)	69.85 (2.750)	77.80 (3.063)	85.72 (3.375)	92.07 (3.625)
15.88 (0.625)	36.50 (1.437)	44.45 (1.750)	52.37 (2.062)	61.90 (2.437)	69.85 (2.750)	77.80 (3.063)	85.72 (3.375)	95.25 (3.750)	103.20 (4.063)
17.45 (0.687)	39.67 (1.562)	49.20 (1.937)	57.15 (2.250)	66.68 (2.625)	76.20 (3.000)	85.72 (3.375)	93.70 (3.688)	103.20 (4.063)	112.73 (4.438)
19.05 (0.750)	42.85 (1.687)	53.97 (2.125)	63.50 (2.500)	73.02 (2.875)	82.55 (3.250)	93.68 (3.688)	103.20 (4.063)	112.73 (4.438)	122.25 (4.813)
20.62 (0.812)	46.02 (1.812)	57.15 (2.250)	68.25 (2.687)	79.38 (3.125)	88.98 (3.503)	100.03 (3.938)	111.10 (4.375)	122.25 (4.813)	131.78 (5.188)
22.23 (0.875)	50.80 (2.000)	61.90 (2.437)	74.60 (2.937)	85.72 (3.375)	96.82 (3.812)	107.95 (4.250)	119.10 (4.689)	131.75 (5.187)	142.88 (5.625)
23.80 (0.935)	53.97 (2.125)	66.68 (2.625)	79.38 (3.125)	92.07 (3.625)	103.20 (4.063)	115.90 (4.563)	128.60 (5.063)	141.30 (5.563)	152.4 (6.000)
25.40 (1.000)	57.15 (2.250)	71.42 (2.812)	84.12 (3.312)	96.82 (3.812)	109.55 (4.313)	123.83 (4.875)	136.50 (5.375)	149.23 (5.875)	163.53 (6.438)

Notes: Use the pressure chart to determine minimum number of seals required. Seals are supplied split unless otherwise stated.

27K

Rod and Piston Seals

Pressure-sensitive, Stacked Set for Hydraulic Sealing

The Chesterton® R27K is a single-acting, stacked V-Ring set with a positive rake design that provides optimum operating performance in heavy-duty hydraulic rod applications. Unlike conventional stacked sets, these designs make contact through the center to enable even loading, which minimizes friction and provides longer sealing life.

The minimal gland pressure enables these sets to withstand greater sliding speed than conventional stacked sets. No readjustment of the seal precompression is needed after installation. The flared, pressure-sensitive lip design provides optimum sealing forces on seal rings, which are reactive to pressure, thus reducing breakaway and frictional force.

The seal set is available in various material combinations to accommodate new or used equipment and can be supplied in split or solid designs.

The R27K is manufactured using a machining process that allows the flexibility to create any size based on equipment dimensions and minimizes tooling cost for new sizes. Each set incorporates a male and female adapter to align and support the seal rings.

Additional profiles have been derived from the original R27K design to address specific needs and applications in the market. These include designs for excessive clearances and deep stuffing boxes.

SPECIFICATIONS



Material (designation)	Temperature °C (°F)	Pressure MPa (psi)	Speed m/s (ft/min)
AWC704 (FKM)	-30 – 200 (-20–400)	16.0 (2320)	1.50 (300)
AWC800 (EU)	-50 – 85 (-60 – 185)	103.5 (15000)	1.00 (200)
AWC825 (EU)	-40 – 85 (-40 – 185)	52.0 (7500)	0.50 (100)
AWC830 (EU)	-35 – 75 (-30 – 175)	35.0 (5000)	0.90 (185)
AWC860 (EU)	-50 – 120 (-60 – 250)	103.5 (15000)	1.25 (250)

PISTON APPLICATION

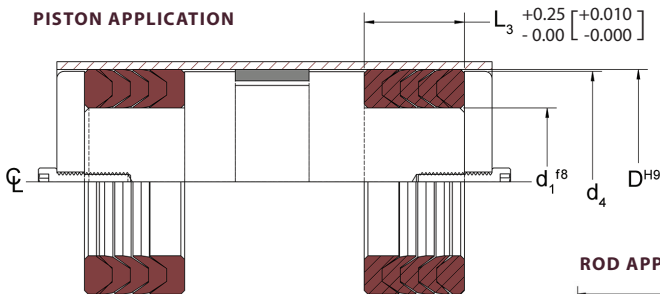

ROD APPLICATION

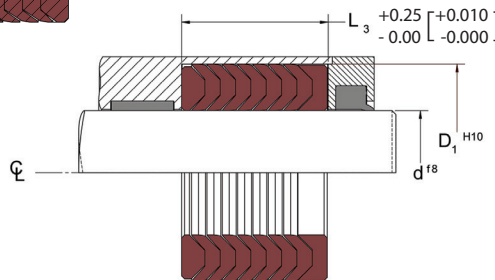

PRODUCT PROFILES



For large diameters with exceptionally deep stuffing boxes the 27K Heavy Duty (HD) seal profile is available as a customer order.

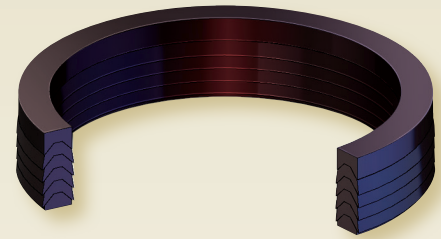

- Minimal gland pressure offers greater speed capability than conventional sets
- Even stack load design minimizes friction and extends service life
- Flared, pressure-sensitive lip; sealing forces are reactive to pressure
- Material combinations designed for use in both new and worn equipment
- Delivered as split components for ease of installation

To place an order Piston Seal:

Product profile: _____
 Material: _____
 Piston groove diameter (d₁): _____
 Piston groove diameter (d₄): _____
 Cylinder bore diameter (D): _____
 Groove height (L₃): _____

To place an order Rod Seal:

Product profile: _____
 Material: _____
 Rod or ram diameter (d): _____
 Bore diameter (D): _____
 Groove height (L₃): _____

27K

Rod Seals

CHART 1 – R27K FLUID PRESSURE - SEAL RING CHART

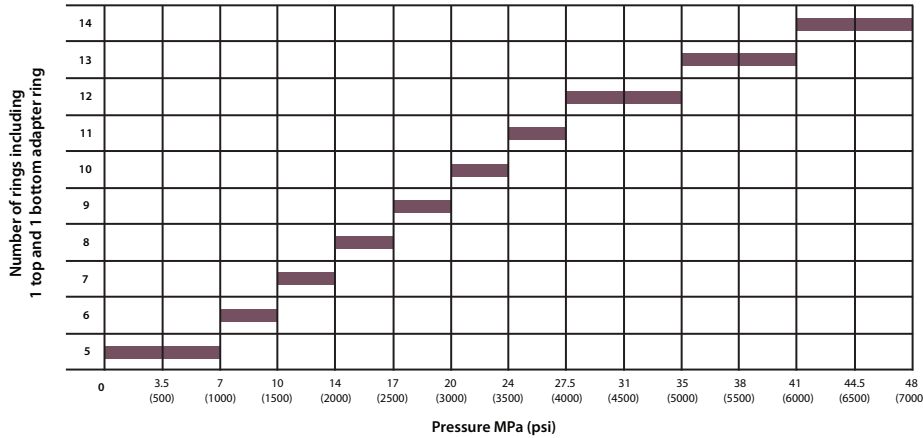

Determine the total number of rings required (including 1 top and 1 bottom adapter ring) based on pressure from Chart 1. For pressure 20 MPa (3000 psi) and above, we suggest the use of an anti-extrusion ring. For pressure above 48 MPa (7000 psi), contact EPS Application Engineering. The minimum recommended seal set consists of a 5-ring set: 1 top adapter, 3 seal rings and 1 bottom adapter ring. Determine the approximate free stack height based on cross section and number of rings of the set from Chart 2 below.

CHART 2 – R27K V-RING APPROXIMATE FREE STACK HEIGHT CHART

Number of Rings	5 Rings	6 Rings	7 Rings	8 Rings	9 Rings	10 Rings	11 Rings	12 Rings	13 Rings	14 Rings
Pressure Rating MPa (psi)	7 (1000)	10 (1500)	14 (2000)	17 (2500)	20 (3000)	24 (3500)	27.5 (4000)	35 (5000)	41 (6000)	48 (7000)
CROSS SECTION mm (inch)	mm (inch)	mm (inch)	mm (inch)	mm (inch)	mm (inch)	mm (inch)	mm (inch)	mm (inch)	mm (inch)	mm (inch)
3.172 ≤ S < 4.773 (0.1249 ≤ S < 0.1879)	12.04 (0.474)	13.94 (0.549)	15.85 (0.624)	17.75 (0.699)	19.66 (0.774)	21.56 (0.849)	23.47 (0.924)	25.40 (1.000)	27.28 (1.074)	29.18 (1.149)
4.773 ≤ S < 6.348 (0.1879 ≤ S < 0.2499)	16.10 (0.634)	19.18 (0.755)	22.25 (0.876)	25.32 (0.997)	28.40 (1.118)	31.47 (1.239)	34.54 (1.360)	37.62 (1.481)	40.69 (1.602)	43.76 (1.723)
6.348 ≤ S < 7.948 (0.2499 ≤ S < 0.3129)	16.83 (0.66)	19.99 (0.787)	23.22 (0.914)	26.44 (1.041)	29.67 (1.168)	32.69 (1.287)	36.12 (1.422)	39.34 (1.549)	42.57 (1.676)	45.80 (1.803)
7.948 ≤ S < 9.523 (0.3129 ≤ S < 0.3749)	20.55 (0.809)	24.51 (0.965)	28.47 (1.121)	32.44 (1.277)	36.40 (1.433)	40.36 (1.589)	44.32 (1.745)	48.29 (1.901)	52.25 (2.057)	56.21 (2.213)
9.523 ≤ S < 11.123 (0.3749 ≤ S < 0.4379)	21.49 (0.846)	25.5 (1.004)	29.51 (1.162)	33.53 (1.320)	37.54 (1.478)	41.55 (1.636)	45.57 (1.794)	49.58 (1.952)	53.59 (2.110)	57.60 (2.268)
11.123 ≤ S < 12.698 (0.4379 ≤ S < 0.4999)	22.50 (0.886)	26.57 (1.046)	30.63 (1.206)	34.70 (1.366)	38.76 (1.526)	42.82 (1.686)	46.89 (1.846)	50.95 (2.006)	55.02 (2.166)	59.08 (2.326)
12.698 ≤ S < 14.298 (0.4999 ≤ S < 0.5629)	25.30 (0.996)	29.97 (1.180)	34.65 (1.364)	39.32 (1.548)	43.99 (1.732)	48.67 (1.916)	53.34 (2.100)	58.01 (2.284)	62.69 (2.468)	67.36 (2.652)
14.298 ≤ S < 15.873 (0.5629 ≤ S < 0.6249)	26.42 (1.040)	31.12 (1.225)	35.81 (1.410)	40.51 (1.595)	45.21 (1.780)	49.91 (1.965)	54.61 (2.150)	59.31 (2.335)	64.01 (2.520)	68.71 (2.705)
15.873 ≤ S < 17.473 (0.6249 ≤ S < 0.6879)	28.50 (1.122)	33.81 (1.331)	39.12 (1.540)	44.42 (1.749)	49.73 (1.958)	55.04 (2.167)	60.35 (2.376)	65.66 (2.585)	70.97 (2.794)	76.28 (3.003)
17.473 ≤ S < 19.048 (0.6879 ≤ S < 0.7499)	33.76 (1.329)	40.03 (1.576)	46.3 (1.823)	52.58 (2.070)	58.85 (2.317)	65.13 (2.564)	71.40 (2.811)	77.67 (3.058)	83.95 (3.305)	90.22 (3.552)
19.048 ≤ S < 22.223 (0.7499 ≤ S < 0.8749)	34.49 (1.358)	40.77 (1.605)	47.04 (1.852)	53.31 (2.099)	59.59 (2.346)	65.86 (2.593)	72.14 (2.840)	78.41 (3.087)	84.69 (3.334)	90.96 (3.581)
22.223 ≤ S < 23.823 (0.8749 ≤ S < 0.9379)	40.77 (1.605)	48.54 (1.911)	56.31 (2.217)	64.08 (2.523)	71.86 (2.829)	79.63 (3.135)	87.40 (3.441)	95.17 (3.747)	102.95 (4.053)	110.72 (4.359)
23.823 ≤ S < 25.398 (0.9379 ≤ S < 0.9999)	40.77 (1.605)	48.54 (1.911)	56.31 (2.217)	64.08 (2.523)	71.86 (2.829)	79.63 (3.135)	87.40 (3.441)	95.17 (3.747)	102.95 (4.053)	110.72 (4.359)
25.398 ≤ S < 26.998 (0.9999 ≤ S < 1.0629)	43.69 (1.720)	51.64 (2.033)	59.59 (2.346)	67.54 (2.659)	75.49 (2.972)	83.44 (3.285)	91.39 (3.598)	99.34 (3.911)	107.29 (4.224)	115.24 (4.537)
26.998 ≤ S < 30.173 (1.0629 ≤ S < 1.1879)	44.704 (1.760)	52.73 (2.075)	60.76 (2.392)	68.78 (2.708)	76.81 (3.024)	84.84 (3.340)	92.86 (3.656)	100.89 (3.972)	108.92 (4.288)	116.94 (4.604)
30.173 ≤ S < 31.748 (1.1879 ≤ S < 1.2499)	52.10 (2.051)	61.8 (2.433)	71.5 (2.815)	81.20 (3.197)	90.91 (3.579)	100.61 (3.961)	110.31 (4.343)	120.02 (4.725)	129.72 (5.107)	139.42 (5.489)
31.748 ≤ S < 33.348 (1.2499 ≤ S < 1.3129)	52.91 (2.083)	62.61 (2.465)	72.31 (2.847)	82.02 (3.229)	91.72 (3.611)	101.42 (3.993)	111.13 (4.375)	120.83 (4.757)	130.53 (5.139)	140.23 (5.521)

11K

Rod Seals

Patented, Simple, Dual Component, Split Seal Assembly for Hydraulic Sealing, Eliminating the Need for Equipment Disassembly

The Chesterton® 11K Rod Seal is a single-acting, two-part unit recommended for use in hydraulic cylinders and presses. The unique, split design minimizes the need for equipment disassembly and shimming. The simplified design reduces friction and wear as observed in conventional elastomer V-ring assemblies. The net effect is an improvement in the life of the equipment.

The 11K has a negative rake lip profile to optimize operating performance and ease installation into the stuffing box cavity. The set is available in various material combinations to accommodate new or used equipment, and can be supplied in split or solid designs. The bottom ring is the primary sealer, while the top ring provides secondary sealing and works as an anti-extrusion ring.

The 11KE is a popular profile used in telescoping cylinders and cylinders with long-stroke or high-side loads. The an O-Ring energized rod seal that offers higher contact loads against the rod.

The 11K can be manufactured using a machining process that allows the flexibility to create any size based on equipment dimensions.

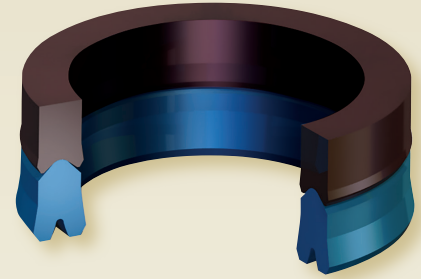

- Negative lip profile optimizes operating performance and eases installation
- No shimming; reduces tedious calculations and future adjustments
- Dual material combination works on both new and worn equipment
- Sizes made to accommodate international standards including ISO and DIN

SPECIFICATIONS



Material (designation)	Temperature °C (°F)	Pressure bar (psi)	Speed m/s (ft/min)
AWC704/704 (FKM)	-30 – 200 (-20 – 400)	35.0 (5000)	1.5 (300)
AWC800/800 (EU)	-50 – 85 (-60 – 185)	103.5 (15000)	1.0 (200)
AWC800/825 (EU)	-50 – 85 (-60 – 185)	35.0 (5000)	0.5 (100)
AWC830/830 (EU)	-35 – 75 (-30 – 165)	345.0 (5000)	0.9 (185)
AWC860/860 (EU)	-50 – 120 (-60 – 250)	103.5 (15000)	1.25 (250)

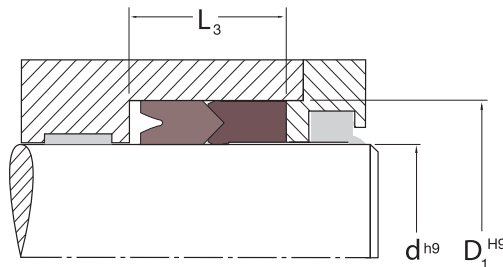

PRODUCT PROFILES



To place an order Rod Seal:

- Product profile: _____
 Material: _____
 Rod or ram diameter (d): _____
 Bore diameter (D): _____
 Groove height (L₃): _____

30K

PTFE Lip Seals

Advanced PTFE Lip Seal for Bearing and Gearbox Protection

The Chesterton® 30K Lip Seals are high performance PTFE lip seals that are ideal for dynamic rotary seal applications. These seals minimize the penetration risk of external contaminants entering the housing and provide excellent sealing service in bearing and gear box applications, which prolongs bearing and equipment service life, even in hostile working environments

The unique 30K lip seal design is mechanically formed to provide optimal sealing force and is available in four distinct PTFE materials developed specifically for sealing applications. The PTFE compounds, coupled with the seal design, provide:

- Excellent fluid compatibility
- Broad range of temperature resistance (low to high temperature)
- High resistance against wear
- High-speed handling capability
- Low friction, reducing contact heat on lips and wear rate
- Outstanding sealing performance compared to conventional rubber lip seals



- High performance lip seals minimize risk of penetration from external contaminants
- Mechanically formed lips provide optimal sealing force to extend MTBR
- Machining process allows the flexibility to create any size without tooling cost
- Static O-Ring seal minimizes rotation and allows for easy installation
- Unique materials ensure plant-wide usage

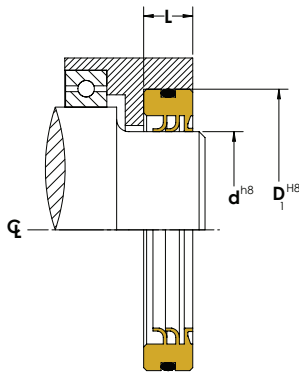

30K
Standard dual lip design



30KW
Integrated wiper dual lip design for large glands >0.325"



30KSW
Integrated wiper design for smaller gland height <0.325"



SPECIFICATIONS



Material (combination) Adapters/Sealer Rings	Size Range mm (inch)	Temperature °C (°F)	Speed m/s (ft/min)	Pressure MPa (psi)	Surface Finish µm (µ inch)	**Recommended Use	Mating Surface (Rockwell C)
AWC100 (PTFE) Polyimide	20 – 600 (0.787 – 23.62)	-30 – 149 (-20 – 300)	Up to 20 (4000)	0.07 MPa (10)	Dynamic 0.2 – 0.4 (8 – 16)	Excellent dry Excellent low viscosity No water and steam	≥45
AWC300 (PTFE) Molybdenum and Glass						Excellent high viscosity Good dry and good in water	≥55
AWC400 (PTFE) Carbon and Graphite					Static 0.4 – 0.8 (16 – 32)	Excellent in water Good dry and low viscosity	≥55
AWC510 (PTFE) Mineral (FDA Listed)						Excellent dry Good in water and steam No petroleum liquids	≥45

Applicable standard: ISO 6194-1

PRODUCT PROFILES

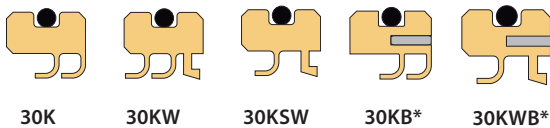

*Metal band reinforced for additional stability

To place an order Lip Seal:

Product profile: _____
 Material: _____
 Rod shaft diameter (d): _____
 Bore diameter (D₁): _____
 Groove height (L): _____

30KC

Cartridge Multi Lip Seal

Cartridge Design for Sealing Powders and Viscous Fluids

The Chesterton® 30KC Polymer Cartridge Seals are used in dynamic rotary seal applications. This cartridge design uses high performance, filled PTFE materials proven to withstand the high shear rates, frictional heat, and abrasives that are common when pumping high-viscosity products or moving powders.

The 30KC is designed with an inboard sealing element, an outboard sealing element, and built-in flushing ports. The inboard lip seals process fluid, the outboard lips seal barrier fluid, and the flush port allows for flushing. The versatile cartridge design is extremely tough and is able to withstand adhesion between the sealing surfaces and shaft due to reacted material and dry running capabilities.

The 30KC high performance, filled PTFE compounds are coupled with the unique seal design to provide excellent fluid compatibility, temperature resistance, and reduced frictional force, thus improving performance and reliability in demanding applications.

All engineered cartridges are custom manufactured to equipment dimensions eliminating the need for equipment modifications.

SPECIFICATIONS



Material* (combination)	Temperature °C (°F)	Speed m/s (ft/min)	Pressure MPa (psi)	Mating Surface (Rockwell C)	Surface Finish µm (µ inch)	**Recommended use
AWC100 (PTFE) Polyimide				45		Excellent dry excellent low viscosity (<2,000cp) powders, oil, resins, glues, paints no water or steam
AWC300 (PTFE) Moly and Glass	-30 – 150 (-20 – 300)	Up to 5.0 (984)	Up to 1.0 (150)	55	Dynamic 0.2 – 0.4 (8 – 16)	Excellent high-viscosity (<2,000cp) Good dry, water or steam
AWC400 (PTFE) Carbon and Graphite				55	Static 0.4 – 0.8 (16 – 32)	Excellent in water or steam Good dry and low viscosity powders, asphalt, clay, slurries
AWC510 (PTFE) Mineral (FDA listed)				45		Excellent dry Good in water or steam chocolate and syrups no petroleum liquids

*Fluoroelastomer O-Rings provided (FDA listed w/AWC510)

**Run-out to 0,15mm (.005")

Applicable standards: ISO 3069

PRODUCT PROFILES



30KC



30KP

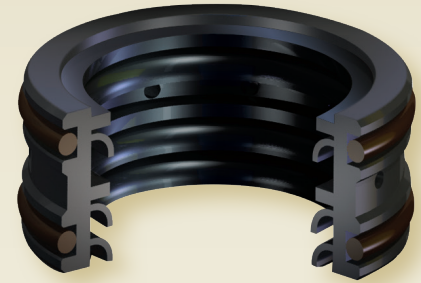
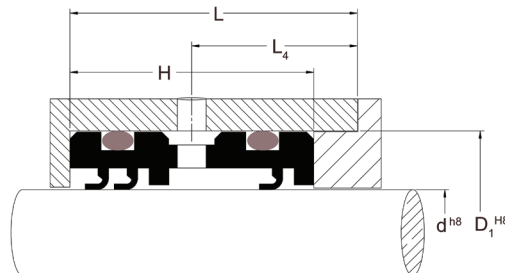

- Outperforms conventional packing and lip seal sets when sealing high-viscosity fluids and dry powders
- Decreases downtime; easy-to-install versatile cartridge design
- Improves performance of compression packing; distinct PTFE materials
- Custom-designed cartridges made to equipment dimensions

To place an order of 30KC and 30KP Cartridge:

Product profile: _____
 Material: _____
 Rod shaft diameter (d): _____
 Stuffing bore diameter (D₁): _____
 Groove height (L): _____
 Distance to flush port (L₄): _____
 Cartridge height (H): _____

Polymer Labyrinth Seal

Unitized, Non-Contacting Seal for Bearing Protection

The Chesterton patented Polymer Labyrinth Seal (PLS) is a non-contact bearing seal designed to provide protection for pumps, gearboxes, and other rotating equipment in splash applications. The unique design minimizes fretting caused by conventional lip seals, and helps to increase bearing and gearbox life by extending the mean time between equipment repairs (MTBR).

This unitized labyrinth seal uses Chesterton’s exclusive polymer to create a non-contacting three-piece seal design that includes a rotor, a stator, and a built-in valve with no wearing parts. During operation, centrifugal force and gravity enable the lubricant to be contained within the labyrinth and flow back into the bearing housing, while outside contaminants are excluded and redirected back to the atmosphere.

The unique design also incorporates a built-in valve that is activated by shaft rotation, which engages during shutdown periods to create a positive seal during idle time, and blocks ingress of external contaminants from entering the housing.

Chesterton’s material technology is manufactured from an advanced, durable, maintenance-friendly thermoset polymer compatible with common bearing and gear oils and offers a cost-effective, alternative solution to other material options. Each seal is custom manufactured to the exact equipment size needed to maximize performance.

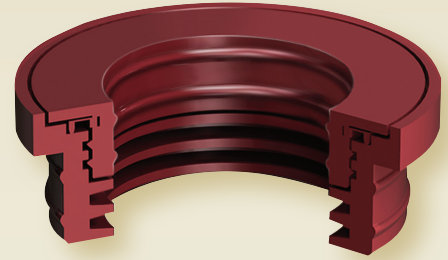

- High performance, non-contact design minimizes fretting caused by lip seals
- Keeps lubrication in and seals out external contamination
- Unitized design and durable non-sparking material provide easy, reliable installation
- Available in a variety of configurations to meet plant-wide equipment needs
- Same-day shipment availability, minimizing downtime and associated costs
- Standard sizes available for popular equipment; custom sizes available upon request
- IP56 (third party certification) resistant to dust and water

SPECIFICATIONS



Material (designation)	Temperature °C (°F)	Speed* m/s (ft/min)	Eccentricity mm (inch)
AWC800 (EU)	-50 – 120 (-60 – 250)	30.50 (6000)	0.75 (0.030)
AWC860 (EU)	-50 – 120 (-60 – 250)	30.50 (6000)	0.75 (0.030)

*Contact engineering for speed beyond these limits.

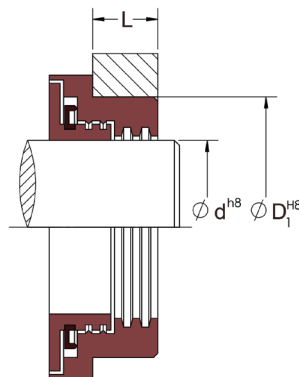

PRODUCT PROFILES



PLS1



PLS2

To place an order for PLS Seal:

Product profile: _____

Material: _____

Rod or ram diameter (d): _____

Groove diameter (D_i): _____

Groove height (L): _____

50K

Mill Rotary Face Seals





High Performance Face Seals for Bearing and Gearbox Protection

Chesterton® 50K Face Seals are high performance face seals for heavy-duty, dynamic rotary seal applications. These seals reduce the ingress of solid particles, dust, and fluids which protects the housing and bearing areas. In severe applications, where exposure to external contaminants is extremely high, the 50K is used as a secondary seal for additional protection in combination with other Chesterton rotary seals, which are in the primary seal position.

The unique design allows 50K face seals to be used in a broad range of equipment across the heavy-duty industries. High performance elastomers create resistance to compression setting, wear, and aging. A broad range of engineered elastomers allow for use in high- and low-temperature conditions, and provide excellent fluid compatibility.

The 50K is manufactured by compression molding technology that provides accurate dimensional and geometrical tolerances as well as improved fitting. According to industrial standards sizing, the 50K is a direct retrofit, which minimizes the need for equipment modification. The 50K is offered in different designs based on application requirements.

PRODUCT PROFILES

Series	Usage
50KA 	with cross section profile that varies according to shaft diameter
50KAX 	with longer lip for heavy-duty applications
50KL 	with narrow axial cross section fit to compact arrangements
50KE 	with special lip design for high performance sealing
50KRME 	with built-in housing for a radial retention metal clamp

Typical Applications

- Back-up rolls of hot and cold rolling mills
- Work rolls of hot and cold rolling mills
- Windmill applications
- Cement plants
- Power plants
- Rotary presses
- Calendar lines

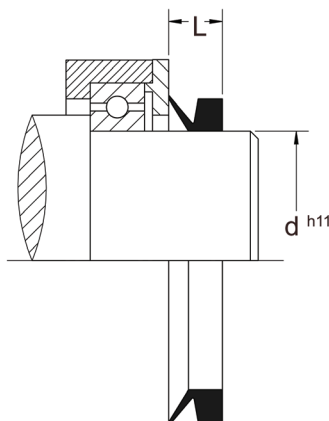

- Robust seal design stops contaminants from entering housing
- High performance elastomers ensure plant-wide usage and long service life
- Optimized lip interference for low friction
- Direct retrofit minimizes equipment modification
- Mount and stretch directly on the shaft for easy installation

To place an order for Face Seal:

Product profile: _____

Material: _____

Rod or ram diameter (d): _____

Groove height (L): _____

50K

Mill Rotary Face Seals

Seal Construction and Installation

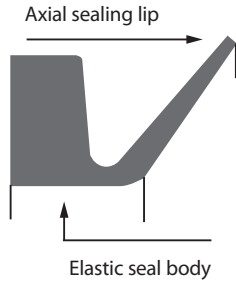

- The face seal is stretched on the shaft so that there is interference between the shaft diameter and seal inner diameter creating radial sealing and clamping force.
- The axial deformation of the conical shaped lip creates axial sealing on the counter-face.

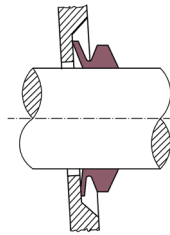
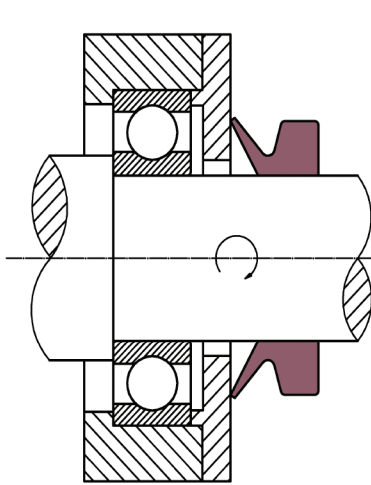

Improved lip design to compensate for shaft misalignments

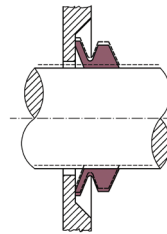

Improved lip designed to compensate for shaft run-out

SPECIFICATIONS



Material	NBR70	FKM70
Lubricating greases	-20°C – 100°C (-4°F – 212°F)	-20°C – 150°C (-4°F – 302°F)
Water	5°C – 100°C (41°F – 212°F)	5°C – 80°C (41°F – 176°F)
Surface speed m/sec (ft/min)	12 (2362)*	20 (3937)*
Technical pressure MPa (psi)	0.03 (4.35)	0.03 (4.35)
Size range mm (inch)** shaft diameter	200 – 1650 (8 – 65)	200 – 1650 (8 – 65)

*At over 8 m/s (1574 ft/min) the seal has to be supported in axial direction while over 12 m/s radial (2362 ft/min) retention is needed.

**Please contact your Chesterton representative for other sizes.

RECOMMENDED SURFACE QUALITY

Ra	Rmax
0.4 - 0.8 µm (16 - 32 µin)	1 – 4 µm (39 – 157 µin)

51K

Mill Rotary Seals

Split Radial Seals for Bearing and Gearbox Protection





Chesterton® 51K Seals are high performance radial seals for heavy-duty, dynamic rotary seal applications. These seals provide long-lasting sealing and superior protection against ingress of solid particles, dust, and fluids and protect bearing houses and gearboxes across the heavy industries, even in the most hostile working environments.

High performance elastomers create resistance to compression setting, wear, and aging. A broad range of engineered elastomers allows use in high- and low-temperature conditions and provides excellent fluid compatibility.

The 51K is manufactured by compression molding technology that provides accurate dimensional and geometrical tolerances and improved fitting. The seal body is equipped with a strong, flexible, fabric back for a tight fit within the seal cavity. A helical garter spring maintains the seal lip contact and sealing force on the shaft.

According to industrial standards sizing, the 51K is a direct retrofit, which minimizes the need for equipment modification. The 51K is offered in different designs based on application requirements.

PRODUCT PROFILES

Series		Usage
51K		with standard style in solid and split form
51KW		with additional dust lip
51KHP		with special lip profile to withstand high pressures up to 0.4 MPa (4 bar) – solid only
51KL		with additional circumferential groove for lubrication

Typical Applications

- Gear drives
- Back-up rolls in hot and cold mills
- Work rolls in hot and cold mills
- Pulp and paper industry
- Pumps
- Propeller shafts
- Wind turbine main bearings
- Rotary applications in cement plants

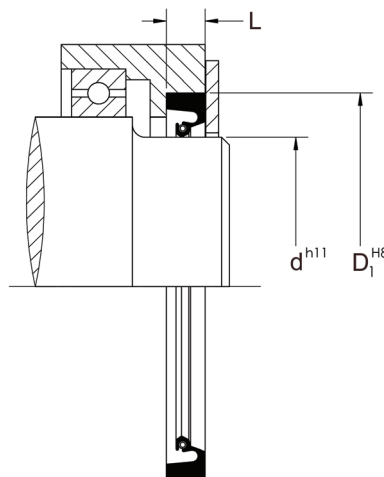

- Long-lasting sealing and superior protection against ingress of foreign materials
- High performance elastomers ensure plant-wide usage and long service life
- Unique lip design combined with auto-lubricated elastomer offers low friction
- Direct retrofit minimizes equipment modification
- Split versions are available for easy installation

To place an order Mill Rotary Seal:

Product profile: _____

Material: _____

Shaft diameter (d): _____

Groove diameter (D₁): _____

Groove height (L): _____

51K

Mill Rotary Seals

Seal Construction

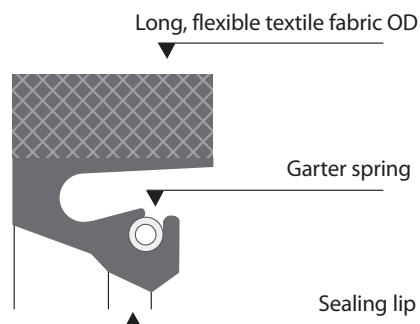

Traditional open garter spring groove design



Improved garter spring groove design from Chesterton for safe installation

INSTALLATION INFORMATION

Parameters	Recommended Values
Shaft hardness	40 – 50 HRC
Shaft surface finish	Ra = 0.3 – 0.5 μm (12 – 20 μin) and Rmax 1 – 2 μm (40 – 80 μin) plunge ground
Shaft tolerance	h11
Housing tolerances	H8
Shaft misalignment	Depending on the surface speed 1.5 mm (0.06") should not be exceeded

Mounting

- The Chesterton 51K Series is always used with a retaining plate
- The retaining plate creates an axial pre-load that adds to the static sealability of the seal
- The plate should be sufficiently dimensioned to avoid distortion when bolting up
- To ease mounting of the seal ring, ensure the housing has a lead-in chamfer

SPECIFICATIONS



Elastomers	NBR80+PTFE	HNBR70	FKM70+PTFE
OD Fabric	Textile + NBR	Textile + HNBR	Textile + FKM
Materials of garter spring	AISI 302 – 316	AISI 302 – 316	AISI 302 – 316
Lubricating greases	-20°C – 100°C (-4°F – 212°F)	-30°C – 150°C (-22°F – 302°F)	-20°C – 200°C (-4°F – 392°F)
Mineral oils	-20°C – 100°C (-4°F – 212°F)	-30°C – 150°C (-22°F – 302°F)	-20°C – 200°C (-4°F – 392°F)
Water	5°C – 100°C (41°F – 212°F)	5°C – 150°C (41°F – 302°F)	5°C – 100°C (41°F – 212°F)
Surface speed m/sec (ft/min)	15 (2952)	20 (3937)	25 (4921)
Technical pressure MPa (psi) 51K, 51KW, 51KL Solid	0.05 (7.25)	0.05 (7.25)	0.05 (7.25)
Technical pressure MPa (psi) 51K, 51KW, 51KL Split	No pressure can be applied	No pressure can be applied	No pressure can be applied
Technical pressure MPa (psi) 51KHP Solid	0.40 (58)	0.40 (58)	0.4 (58)
Size range mm (inch)* Seal OD	300 – 1200 (12 – 47)	300 – 1200 (12 – 47)	300 – 1200 (12 – 47)

*Please contact your Chesterton representative for other sizes.

52K

Mill Rotary Seals

Radial Seals for Bearing and Gearbox Protection



Chesterton® 52K seals are high performance radial seals for heavy-duty, dynamic rotary seal applications. These seals provide long-lasting sealing and superior protection against ingress of solid particles, dust, and fluids and protect bearing houses and gearboxes across the heavy industries, even in the most hostile working environments.

High performance elastomers provide resistance to compression setting, wear, and aging. A broad range of engineered elastomers allows use in high- and low-temperature conditions and provides excellent fluid compatibility.

The 52K is manufactured by compression molding technology that provides accurate dimensional and geometrical tolerances. The unique design with a flexible stiffener ring ensures improved fitting in the seal cavity and allows installation in stuffing boxes without end covers. A helical garter spring maintains the seal lip contact and sealing force on the shaft.

According to industrial standards sizing, the 52K is a direct retrofit, which minimizes the need for equipment modification. The 52K is offered in different designs based on application requirements.

PRODUCT PROFILES

Series		Usage
52K		with standard style
52KW		with additional dust lip
52KHP		with special lip profile to withstand high pressures up to 0.4 MPa (4 bar)

Typical Applications

- Gear drives
- Back-up rolls in hot and cold mills
- Work rolls in hot and cold mills
- Pulp and paper industry
- Pumps
- Windmill applications
- Rotary applications in cement plants

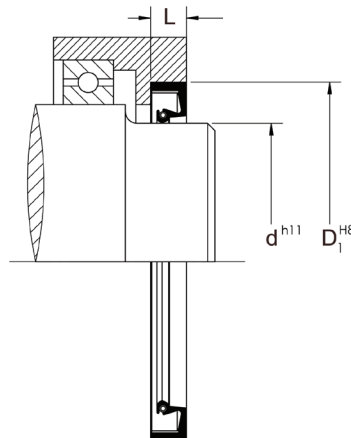

- Long-lasting sealing and superior protection against ingress of foreign materials
- High performance elastomers ensure plant-wide usage and long service life
- Unique lip design combined with auto-lubricated elastomer for low friction
- Direct retrofit minimizes equipment modification
- Unique design with flexible stiffener ring ensures improved fitting

To place an order Mill Rotary Seal:

Product profile: _____

Material: _____

Shaft diameter (d): _____

Groove diameter (D₁): _____

Groove height (L): _____

52K

Mill Rotary Seals

Seal Construction

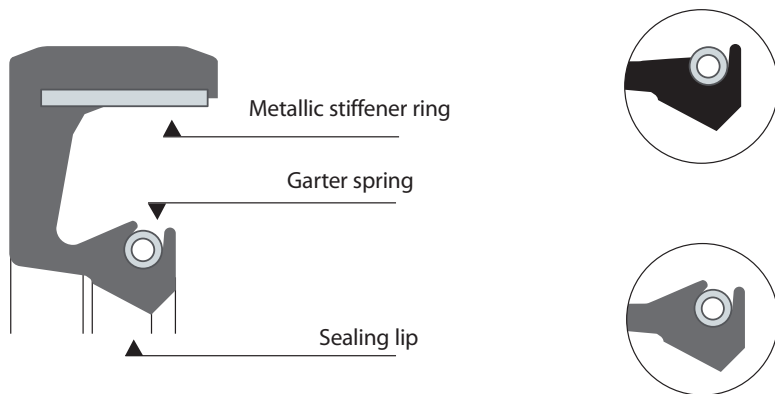

Traditional open garter spring groove design

Improved garter spring groove design from Chesterton for safe installation

INSTALLATION INFORMATION

Parameters	Recommended Values
Shaft hardness	40 – 50 HRC
Shaft surface finish	Ra = 0.3 – 0.5 µm (12 – 20 µin) and Rmax 1 – 2 µm (40 – 80 µin) plunge ground
Shaft tolerance	h11
Housing tolerances	H8
Shaft misalignment	Depending on the surface speed 1.5 mm (0.06 in) should not be exceeded

Mounting

- The Chesterton 52K Series can be used without a retaining plate
- To ease seal ring mounting, ensure the housing has a lead-in chamfer

SPECIFICATIONS



Elastomers	NBR80+PTFE	FKM70+PTFE
Material of metal case	C72 tempered	C72 tempered
Material of garter spring*	AISI 302 – 316	AISI 302 – 316
Lubricating greases	-30°C – 100°C (-22°F – 212°F)	-20°C – 200°C (-4°F – 392°F)
Mineral oils	-30°C – 100°C (-22°F – 212°F)	-20°C – 200°C (-4°F – 392°F)
Water	5°C – 100°C (41°F – 212°F)	5°C – 100°C (41°F – 212°F)
Surface speed m/sec (ft/min)	15 (2952)	25 (4921)
Technical pressure MPa (psi)	0.05 (7.25)	0.05 (7.25)
Size range mm (inch)** Seal OD	300 – 1200 (12 – 47)	300 – 1200 (12 – 47)

*PVC cover available upon request to avoid dust entering garter spring.

**Please contact your Chesterton representative for other sizes.

53K

Premium Mill Rotary Seals







High Performance Seals for Bearing and Gearbox Protection

Chesterton® 53K Seals are high performance radial seals for heavy-duty, dynamic rotary seal applications. These seals provide long-lasting sealing and protective solutions that withstand high speeds and large misalignment of shafts and rolls in heavy industry.

The outer metal case of 53K is cold pressed. The elastomer part is manufactured by compression molding technology and is vulcanized to the metal case, which provides very tight dimensional and geometrical tolerances. The unique design, with a flat, outer metal case, ensures a better fit in the seal cavity and an improved centric position. Additionally, this design allows installation in stuffing boxes without end covers.

According to industrial standards sizing, the 53K is a direct retrofit, which minimizes the need for equipment modification. The 53K is offered in different designs based on application requirements.

PRODUCT PROFILES

Series	Usage
53K 	with standard style with garter-finger spring system
53KW 	with additional dust lip
53KHP 	with special, robust lip profile to withstand high pressures up to 0.1 MPa (1 bar)
53KL 	with special, optimized lip interference for high-speed applications
53KLHS 	with special, low lip interference for ultra high-speed applications
53KLPT 	with integrated (vulcanized) PTFE lip tip

Typical Applications

- High-speed gear drives
- High-speed back-up rolls in cold mills
- Work rolls in hot and cold mills
- Aluminum foil mills
- Paper machines
- Cement plants
- Power plants



- Unique lip pre-load system with highly flexible garter-finger spring combination
- Large shaft run-out compensation capability
- Unique lip design combined with autolubricated elastomer offers low friction and ultra-high surface speed
- Direct retrofit minimizes equipment modification
- High performance elastomers ensure plant-wide usage and long service life

53K

Premium Mill Rotary Seals

Seal Construction

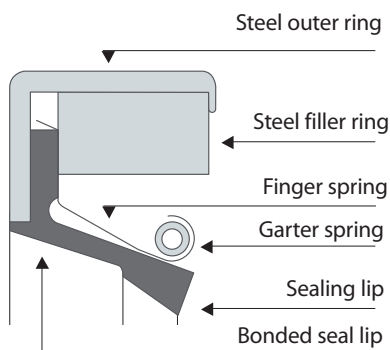

- The service life and performance of the seal are largely dependent upon the pre-load of the seal lip on the shaft. In this respect the 53K design offers a significant advantage over conventional garter spring seal types as a result of its highly elastic garter-finger spring combination.
- Shaft misalignment (shaft deflection, bearing clearance, out of round and run-out) creates changes to the lip pre-load that can in conventional seals compromise either or both lip tip sealing integrity and seal life.
- The finger-garter spring combination in 53K largely minimizes the effect of external forces causing changes in lip tip pre-load and therefore is more likely to maintain the fluid film underneath the lip the condition of which has the greatest effect on seal service life and performance.

SPECIFICATIONS



Elastomers	NBR80+PTFE	FKM70+PTFE
Material of metal case	FePO ₃	FePO ₃
Material of steel filler ring	Fe37	Fe37
Material of spring carrier	AISI 301	AISI 301
Materials of garter spring	AISI 316	AISI 316
Lubricating greases	-20°C – 100°C (-4°F – 212°F)	-20°C – 200°C (-4°F – 392°F)
Mineral oils	-20°C – 100°C (-4°F – 212°F)	-20°C – 200°C (-4°F – 392°F)
Surface speed m/sec (ft/min)	25 (4921)	25 – 35 (4921 – 6889)
Technical pressure MPa (psi) 53K, 53KW, 53KL, 53KLHS 53KLPT	0.05 (7.25)	0.05 (7.25)
Technical pressure MPa (psi) 53KHP	0.1 (14.5)	0.1 (14.5)
Size range mm (inch)* Seal OD	300 – 1200 (12 – 47)	300 – 1200 (12 – 47)

*Please contact your Chesterton representative for other sizes.

SHAFT AND HOUSING TOLERANCES

Shaft Ø mm (inch)	Housing Bore Ø mm (inch)
<= 100 +/- 0.08 (<= 4 +/- 0.00315)	<= 76 +/- 0.025 (<= 2.99 +/- 0.001)
101 – 150 +/- 0.10 (4.01 – 5.9 +/- 0.004)	77 – 150 +/- 0.04 (3 – 5.9 +/- 0.0016)
151 – 250 +/- 0.13 (5.91 – 9.842 +/- 0.005)	151 – 255 +/- 0.05 (5.91 – 10 +/- 0.002)
>= 250 +/- 0.25 (9.85 +/- 0.01)	256 – 510 + 0.05/-0.10 (10.1 – 20 +0.002/-0.004)
	511 – 1.015 + 0.05/-0.15 (20.10 – 40 +0.002/0.006)
	>1.015 +0.05/-0.25 (40.10 +0.002/-0.01)

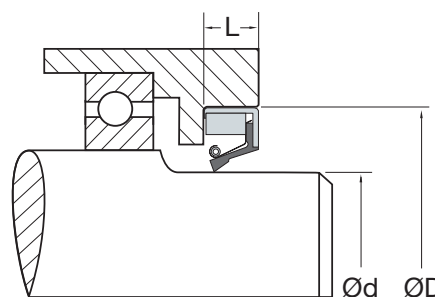

SHAFT HARDNESS AND SURFACE FINISH TOLERANCES

Speed m/sec (ft/min)	Max Roughness		Hardness (HRC)
	Ra µm (µin)	Rmax µm (µin)	
<= 10 (1968)	0.5 – 0.6 (20 – 24)	2 – 3 (80 – 120)	30
11 – 16 (2165 – 3150)	0.3 – 0.5 (12 – 20)	1 – 2 (40 – 80)	40
>16 (3150)	0.2 – 0.3 (8 – 12)	0.8 – 1 (32 – 40)	50

To place an order Mill Rotary Seal:

Product profile: _____

Material: _____

Shaft diameter (d): _____

Groove diameter (D): _____

Groove height (L): _____

24K

Split Slow Rotary Seals

Robust Design for Slow Rotating Applications Exposed to Large Shaft Runout

Chesterton® 24K Rotary Split Seals, with their robust design, are ideal for low-speed dynamic rotary seal applications exposed to large shaft runout. These seals provide excellent sealing and protective solutions for heavy-duty rotating equipment, even in severe application conditions, thus prolonging bearing and equipment service life.

The flexible, dynamic lip of the 24K creates a positive seal and compensates considerably for shaft runout, which will improve the sealability and reliability of old, worn equipment. The optimum lip pre-load in combination with high performance polyurethane helps to minimize frictional drag on the seal.

The robust, static lip design provides tight sealing in the seal cavity and allows for seal installation in either tandem or back-to-back configurations which provides the flexibility to vary seal systems according to hardware arrangement, operating conditions, and equipment demands. Further, the robust lip provides protection against seal rotation with the shaft.

The 24K split configuration simplifies the installation by minimizing downtime for seal replacement and improving uptime/availability of the equipment in operation. The robust seal design minimizes stretching, bunching, and twisting during installation, which helps to reduce the probability of improper installation.

The 24K is manufactured individually using our unique machining process that minimizes the need for tooling costs associated with new sizes. The seals are made-to-order; geometrical and dimensional design considered according to actual equipment arrangement, dimensions, and shaft run-out.

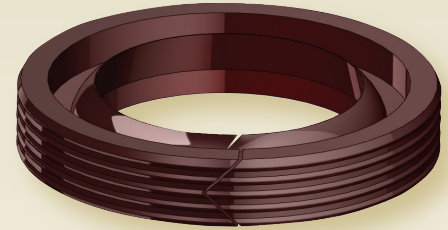

- Flexible dynamic lip design for large shaft runout compensation
- Split configuration simplifies installation
- Positive rake lip design wipes contaminants away from the mating surface
- Robust static lip design allows stack set arrangement and provides stability
- Excellent abrasion-resistance; withstands demanding environments
- Manufacturing process allows flexibility to create any size

SPECIFICATIONS



Material (designation)	Temperature °C (°F)	Pressure MPa (psi)	Speed m/s (ft/min)
AWC704 (FKM)	-30 – 200 (-20 – 400)	0.7 (100)	1.00 (200)
AWC 800 (EU)	-20 – 85 (-4 – 185)	0.7 (100)	0.25 (50)
AWC825 (EU)	-40 – 85 (-40 – 185)	0.7 (100)	0.25 (50)
AWC830 (EU)	-35 – 75 (-30 – 175)	0.7 (100)	0.50 (100)
AWC860 (EU)	-50 – 120 (-60 – 250)	0.7 (100)	0.75 (150)

PRODUCT PROFILES



24K

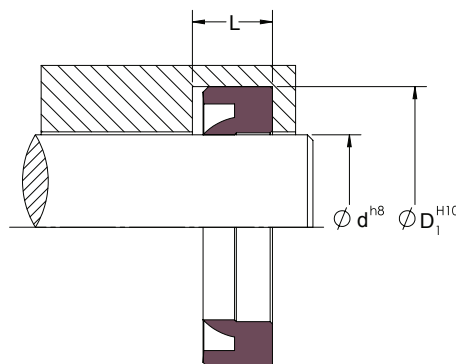

To place an order for 24K Rotary Seal:

Product profile: _____

Material: _____

Rod or ram diameter (d): _____

Bore diameter (D₁): _____

Groove height (L): _____

33K

Split Rotary Seal

Unitized Split Seal for Bearing and Gearbox Protection

The Chesterton® patented 33K split design minimizes the need for and associated costs of equipment disassembly, and improves seal performance over conventional lip seals. This innovative, split technology minimizes penetration of external contaminants entering the housing, and provides excellent service in bearing and gear box applications.

This seal is a combination of two different material types. The unitized housing is made from abrasion-resistant thermoset polyurethane that energizes and provides easy mounting to the equipment. The sealing interface is made from high performance, filled PTFE material developed specifically for sealing applications. The seal can be installed in either direction, which allows the end user to locate sealer rings away from a previously damaged shaft.

The 33K is manufactured using our unique machining process that minimizes the need for tooling costs associated with new sizes.



- Patented split design minimizes the need for equipment disassembly
- Unitized design provides easy mounting to the equipment
- Proven to outperform conventional lip seals
- Flexible design, locate sealer rings away from previously fretted shaft
- Large sizes available; cost-effective solution to equipment teardown

SPECIFICATIONS



Material (combination) Adapters/ Sealer Rings	Temperature °C (°F)	Speed m/s (ft/min)	Pressure bar (psi)	Recommended Use	Mating Surface (Rockwell C)
---	---------------------	--------------------	--------------------	-----------------	-----------------------------

AWC800 Adapters (EU)

AWC100 (PTFE) Polyimide	85 (185)	12.70 (2500)	0.07 (1)	Excellent dry. Excellent low viscosity.	≥45
AWC300 (PTFE) Moly and Glass	85 (185)	12.70 (2500)	0.07 (1)	Excellent high viscosity. Good dry and good in water.	≥55
AWC400 (PTFE) Carbon and Graphite	85 (185)	12.70 (2500)	0.07 (1)	Excellent in water. Good dry and low viscosity.	≥55

AWC860 Adapters (EU)

AWC100 (PTFE) Polyimide	121 (250)	12.70 (2500)	0.7 (10)	Excellent dry. Excellent low viscosity. No water and steam.	≥45
AWC300 (PTFE) Moly and Glass	121 (250)	12.70 (2500)	0.07 (1)	Excellent high viscosity. Good dry and good in water.	≥55
AWC400 (PTFE) Carbon and Graphite	121 (250)	12.70 (2500)	0.07 (1)	Excellent in water. Good dry and low viscosity.	≥55

Applicable standard: ISO 6194-1

PRODUCT PROFILES

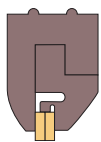

33K

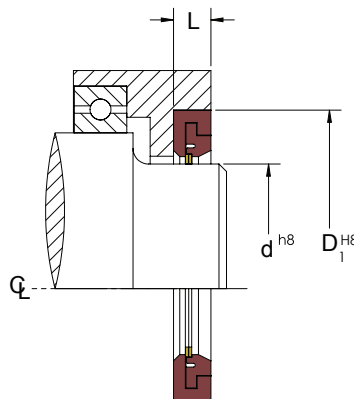

To place an order 33K Rotary Seal:

Product profile: _____

Material: _____

Rod shaft diameter (d): _____

Bore diameter (D): _____

Groove height (L): _____

Matrix Rotary Seal

Easy-to-Install Patented Split Rotary Seal for Worn Shaft Applications

The Chesterton® patented Matrix Rotary Seal is a split-bearing seal developed to work on worn equipment and large runout shafts. This unique seal protects pumps, gearboxes, and other rotating equipment.

The innovative split design minimizes the need for equipment disassembly, and minimizes equipment downtime to ensure optimal continuous operation of critical equipment.

This product is a robust, maintenance-friendly, easy-to-install solution to address equipment with:

- Worn Shafts/Sleeves
- High Vibration
- Large Runout
- Blind Installations

Targeted applications: Pumps, gearboxes, conveyors, motors, and fans

SPECIFICATIONS



Seal Housing	Sealing Element	Temp °C (°F)	Speed m/s (ft min)	Pressure bar (psi)	Eccentricity mm (Inch)d	Chemical Resistance
AWC800	1727NP	85 (185)	15.00 (3000)	0.07 (1)	up to 1.5 (0.060)	Compatible with all commonly used bearing and gear box oils and greases
AWC860	1727NP	120 (250)	15.00 (3000)	0.07 (1)	up to 1.5 (0.060)	

Matrix Split Seal Design and Function

The innovative unitized design combines Chesterton’s leading polyurethane and impregnated synthetic fiber packing technology to maximize seal performance and reliability.

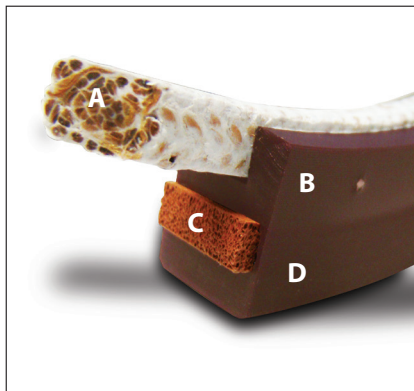

- A. Compression Packing** – Impregnated synthetic fiber creates a seal against rotating shaft
- B. Nylon Pins** – Minimizes rotation of compression packing
- C. Energizer** – Closed cell foam energizes compression packing against the shaft to help create a seal
- D. Polymer Housing** – Durable, flexible material unitizes the seal assembly and energizes the sealing element

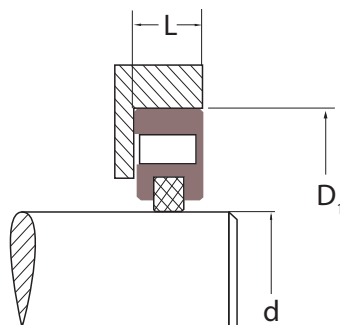

PRODUCT PROFILES



MATRIX

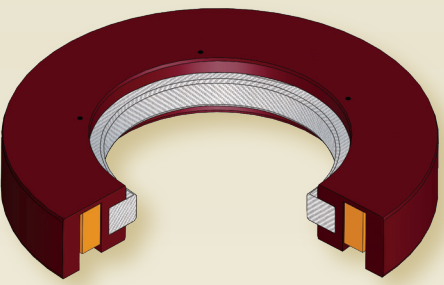

- Engineered for large runout and worn equipment
- Minimizes cumbersome equipment teardown and minimizes downtime
- Excludes external contamination, preserves internal lubrication
- Flexible design provides ease of installation
- Manufactured to custom equipment dimensions and requirements
- Covers all industries including steel, mining, paper, and agricultural

To place an order for Matrix Seal:

Product profile: _____
 Material: _____
 Shaft diameter (d): _____
 Groove diameter (D₁): _____
 Groove height (L): _____

Split Polymer Labyrinth Seal

Noncontact Split Rotary Seal for Bearing Protection

The Chesterton® patent-pending Split Polymer Labyrinth Seal (SPLS) is a noncontact, split rotary seal for splash-lubricated bearing protection in large pumps, gearboxes, and other rotating equipment. This split seal reduces installation time and outperforms conventional lip seals in operation.

Conventional lip seals have a high probability of fretting and wear on the shaft which leads to reduced life of the equipment. The SPLS design reduces the chance of fretting and wear. It also helps to increase bearing and gearbox life by extending the mean time between equipment repairs (MTBR).

This SPLS uses Chesterton’s exclusive, industry-leading thermoset polymer to create a noncontact, three-piece seal design that includes a rotor with an integrated valve, a stator, and a metal clamp with no wearing parts.

While in operation, centrifugal forces and gravity enable the lubricant to stay contained within the labyrinth and flow back into the bearing housing, while outside contaminants are excluded and redirected back to the atmosphere.

Chesterton’s advanced, durable, maintenance-friendly thermoset polymers are compatible with common bearing and gear oils and offer a cost-effective alternative to other material options. Each seal is custom manufactured to the exact equipment size needed to maximize performance.

SPECIFICATIONS



Material (designation)	Temperature °C (°F)	Speed m/s (ft/min)*	Eccentricity mm (inch)
AWC800 (EU)	-40 – 93 (-40 – 200)	30.50 (6000)	0.75 (0.030)

*Contact engineering for speed beyond these limits.

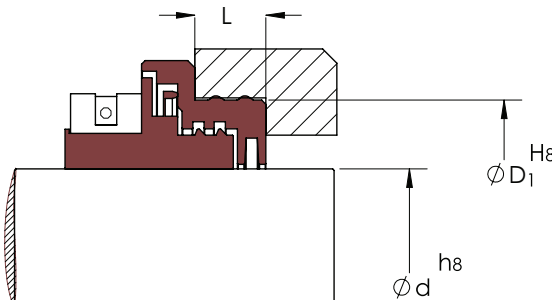

PROFILES



SPLS1

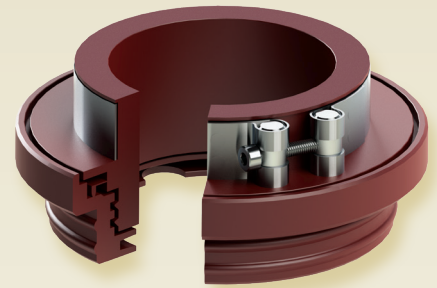

- A split, noncontact design that reduces installation time and minimizes downtime for critical equipment.
- Reduces the chances of fretting caused by lip seals
- Keeps lubrication in and seals out external contamination
- Unitized design and durable material provide easy, reliable installation
- Available in a variety of configurations to meet plant-wide equipment needs
- Standard sizes available for popular equipment; custom sizes available upon request
- IP65 protection against water jets and dust

To place an order for SPLS Seal:

Product profile: _____
 Material: _____
 Rod or ram diameter (d): _____
 Groove diameter (D₁): _____
 Groove height (L): _____

14K

Restriction Bushings

Robust, Restriction Bushing for Rotary Equipment

Chesterton® 14K Restriction Bushings are used in rotary equipment to form a barrier between the sealing device in the stuffing box or the pump impeller housing and the fluid in the mixing tank. The restriction that is produced reduces flush requirements and helps to minimize suspended abrasive particles from entering the stuffing box area, thus prolonging the service life of installed packing sets or mechanical seals.

The 14K seal tapered lip design conforms to equipment eccentricities to minimize the annular gap formed around the rotating shafts, thereby creating the smallest possible free flow area for controlling flush flow rates. A secondary beneficial effect of increasing pressure drop with the 14K is that the flush around the shaft becomes very uniform, which is critical in minimizing particulates from entering the stuffing box envelope. The dynamic lip acts as a check valve when flush is shut-off.

The solid 14K reduces the number of packing rings required in the stuffing box which helps to reduce frictional force. Further, it helps to keep the lantern ring in its position and maintains the optimum flush rate. The 14K is manufactured from superior abrasion-resistant polymers, while the PTFE compound offers broad media compatibility with high-temperature capability.

The 14K restriction bushings are manufactured using a machining process that allows the flexibility to create any size, based on equipment dimensions. Each bushing is individually manufactured and provides excellent performance in pumps, agitators, mixers, refiners, and other equipment.

SPECIFICATIONS



Material (designation)	Temperature °C (°F)	pH
AWC520 (PTFE)	Up to 200 (400)	0 – 14
AWC800 (EU)	Up to 85 (185)	4 – 10

*Contact Applications Engineering for speed, beyond these limits
Applicable standard: ISO3069

Flow rates — approximated for water by the following formulas

Flow rate, liter/min =
 $([0.115 \times \Delta \text{ pressure, bar}] + [0.064]) \times \text{shaft diameter, mm}$
 Flow rate, gallon/min =
 $([0.053 \times \Delta \text{ pressure, psi}] + [0.43]) \times \text{shaft diameter, inch}$

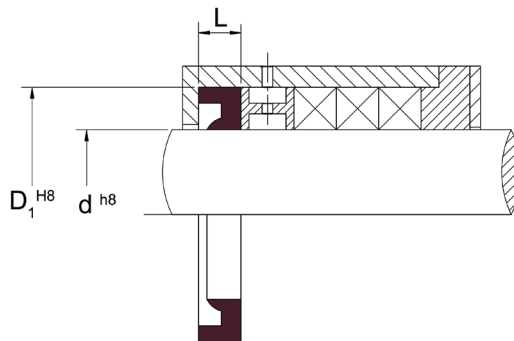

PRODUCT PROFILES

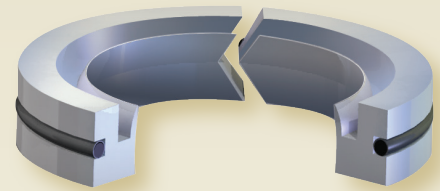

- Split design simplifies installation
- Minimize risk, of particles entering into stuffing box; extend packing and seal life
- Tapered lip design controls fluid bypass and helps increase pumps efficiency
- Dual materials available; plant-wide usage
- Reduces the number of packing rings required which reduces frictional force
- Designed for pumps of all types including agitators, mixers, and refiners

To place an order a 14K Restriction Bushing:

Product profile: _____
 Material: _____
 Rod shaft diameter (d): _____
 Bore diameter (D₁): _____
 Groove height (L): _____

14KLR

Lantern Rings

Robust, Restriction Bushing for Rotary Equipment

Chesterton® 14KLR Lantern Rings are used in rotating equipment to improve lubrication as well as cooling for packing rings and lip seals by distributing the liquid uniformly around the circumference of the shaft, where the external lubrication is utilized. A further function of the 14KLR Lantern Rings is to keep abrasives and chemicals flushed.

The 14KLR greatly improves the service life of compression packing in pump, mixer, and rotary airlock stuffing box areas. Lantern rings are also used in bearing protection applications with great results, as they help to duct lubricant and provide better lubrication for the rotary lip seal.

14KLR incorporates multiple radial holes to provide proper and uniform fluid distribution. Lead-in chamfers on the OD of the rings make for easy installation.

The 14KLR is manufactured from superior abrasion-resistant polymers, while PTFE compound offers broad media compatibility with high- temperature capability.

The 14KLR Lantern Rings are manufactured using a machining process that allows the flexibility to create any size based on equipment dimensions. Each bushing is individually manufactured and provides excellent performance in pumps, agitators, mixers, refiners, and other equipment. 14KLR is available in solid and split or half-ring versions for ease of installation and maintenance.



- Improved lubrication and cooling effect helps to extend service life of packing and lip seals
- Keeps abrasives and chemicals flushed
- Split or half-ring design for ease of installation
- Different material options for plant-wide usage
- Designed for pumps of all types including agitators, mixers, and refiners

SPECIFICATIONS



Material (designation)	Temperature °C (°F)	pH Range
AWC800 (EU)	Up to 85 (185)	4 – 10
AWC860 (EU)	Up to 120 (250)	4 – 10
AWC300 PTFE (Glass-Filled)	Up to 200 (400)	0 – 14
AWC510 PTFE (Polyimide-Filled)	Up to 200 (400)	0 – 14
AWC520 PTFE (Virgin)	Up to 200 (400)	0 – 14

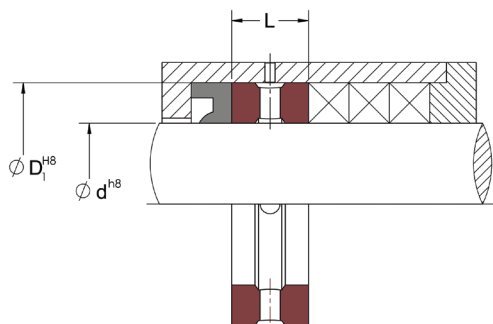

PRODUCT PROFILES



14KLR

To place an order a 14KLR Lantern Ring:

Product profile: _____
 Material: _____
 Rod shaft diameter (d): _____
 Bore diameter (D_h): _____
 Groove height (L): _____

20KD

Face and Static Seals

High Performance O-Ring Upgrade for Static Sealing

The Chesterton® 20K D-Ring is a continuous compression seal designed for use in static applications, and is often applied as an upgrade to conventional face seals or O-Rings. The 20KD design provides excellent performance in static applications in hydraulic or pneumatic equipment including flange and valve control units.

The 20KD optimum design provides minimum seal deformation through a better fit in the seal cavity and excellent pressure distribution through the seal cross section, which is accomplished through better geometrical and dimensional stability (Figure 1 on the next page). 20K D-Rings can withstand higher operating pressures compared to conventional O-Rings.

PISTON APPLICATION

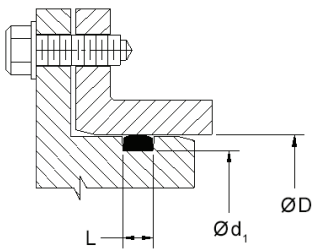

ROD APPLICATION

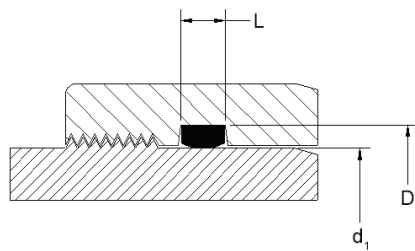

AXIAL/FACE APPLICATION

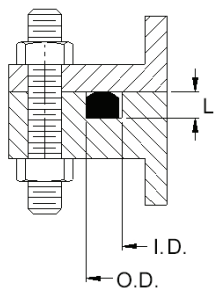

PRODUCT PROFILES

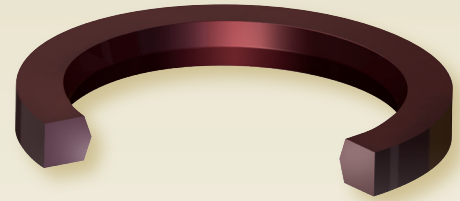
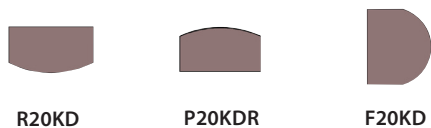

- Upgrade performance from conventional face seal and O-Ring designs
- Superior wear and extrusion resistance versus conventional materials
- Low compression set characteristics
- Unique manufacturing process allows the flexibility to create any size
- Sizes made to accommodate international standards including ISO and DIN

To place an order for Rod Seal:

Product profile: _____
 Material: _____
 Rod or ram diameter (d): _____
 Bore diameter (D): _____
 Groove height (L): _____

To place an order for Piston Seal:

Product profile: _____
 Material: _____
 Piston groove diameter (d): _____
 Cylinder bore diameter (D): _____
 Groove height (L): _____

To place an order for Axial/Face Seal:

Product profile: _____
 Inner diameter (ID): _____
 Outer diameter (OD): _____
 Groove height (L): _____

20KD

Face and Static Seals

SPECIFICATIONS



Material (designation)	Size Range* mm (inch)	Temperature °C (°F)	Pressure MPa (psi)
AWC704 (FKM)	6 – 304.8 (1/4 – 12)	-30 – 200 (-20 – 400)	16.0 (2320)
AWC800 (EU)	6 – 2540 (1/4 – 100)	-50 – 85 (-60 – 185)	103.5 (15000)
AWC825 (EU)	6 – 2540 (1/4 – 100)	-40 – 85 (-40 – 185)	52.0 (7500)
AWC830 (EU)	6 – 254 (1/4 – 10)	-35 – 75 (-30 – 175)	52.0 (7500)
AWC860 (EU)	6 – 508.0 (1/4 – 20)	-50 – 120 (-60 – 250)	103.5 (15000)

* Please contact your Chesterton representative for larger sizes.
 Applicable standard: ISO 3601-2

FIGURE 1. HOW THE 20K D-RING PERFORMS INSTALLED AND UNDER PRESSURE

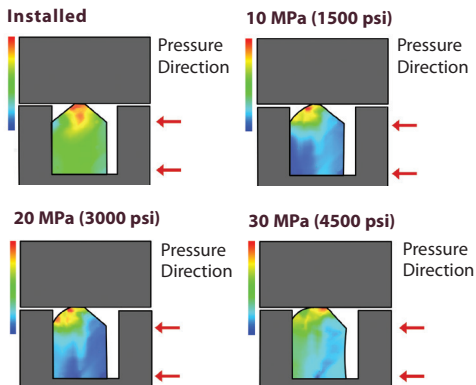

OR

Face and Static Seals

O-Ring for Static Sealing

Chesterton offers O-Rings for static applications in several materials including FKM, FEPM, NBR, and Polyurethanes. The OR1 designation represents O-Rings made from our industry leading thermoset polyurethanes, which offer excellent extrusion resistance. The OR designation refers to all other commonly used materials.

A continuous, high performance compression seal that is most commonly designed for use in static applications. Designs are available for internal face sealing as well as external face sealing commonly found in single- or double-acting applications.

SPECIFICATIONS



Material (designation)	Temperature °C (°F)	Pressure MPa (psi)
AWC704 (FKM)	-30 – 200 (-20 – 400)	16.0 (2320)
AWC800 (EU)	-50 – 85 (-60 – 185)	103.5 (15000)
AWC825 (EU)	-40 – 85 (-40 – 185)	52.0 (7500)
AWC830 (EU)	-35 – 75 (-30 – 175)	52.0 (7500)
AWC860 (EU)	-50 – 120 (-60 – 250)	103.5 (15000)

PISTON APPLICATION

ROD APPLICATION

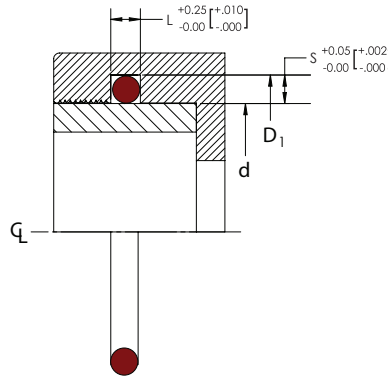
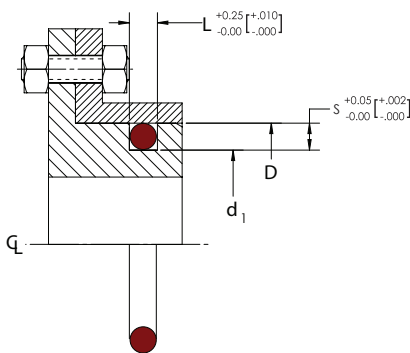

- Polyurethane O-Rings offer superior wear extrusion and resistance versus conventional materials
- Low compression set characteristics
- Unique manufacturing process allows the flexibility to create any size
- Sizes made to accommodate international standards including ISO and DIN

To place an order for Rod Seal:

Product profile: _____
 Material: _____
 Rod or ram diameter (d): _____
 Bore diameter (D): _____
 Groove height (L): _____

To place an order for Piston Seal:

Product profile: _____
 Material: _____
 Piston groove diameter (d): _____
 Cylinder bore diameter (D): _____
 Groove height (L): _____

To place an order for Axial/Face Seal:

Product profile: _____
 Inner diameter (ID): _____
 Outer diameter (OD): _____
 Groove height (L): _____

PRODUCT PROFILES



OR1 OR

AXIAL APPLICATION

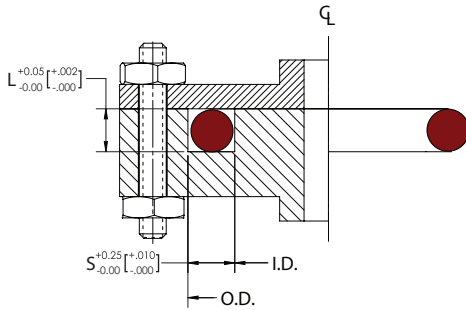

DESIGN GUIDE

STATIC SEALING – Inch		1/16"	3/32"	1/8"	3/16"	1/4"
O-Ring Cross Section		0.070	0.103	0.139	0.210	0.275
A – Gland Depth		0.048	0.077	0.109	0.168	0.222
B – Groove Width		0.054	0.083	0.115	0.176	0.232
C – Maximum Diametrical Clearance		0.090	0.140	0.180	0.280	0.370
R – Maximum Groove Radius		0.006	0.008	0.010	0.012	0.012
		0.015	0.020	0.025	0.035	0.050
DYNAMIC SEALING – Inch		1/16"	3/32"	1/8"	3/16"	1/4"
O-Ring Cross Section		0.070	0.103	0.139	0.210	0.275
A – Gland Depth		0.055	0.088	0.120	0.184	0.234
		0.057	0.090	0.124	0.188	0.240
B – Groove Width		0.090	0.140	0.180	0.280	0.370
		0.100	0.150	0.190	0.290	0.380
C – Maximum Diametrical Clearance		0.005	0.006	0.007	0.008	0.008
R – Maximum Groove Radius		0.015	0.020	0.025	0.035	0.050

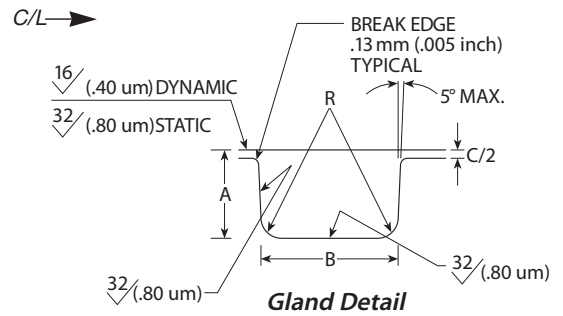
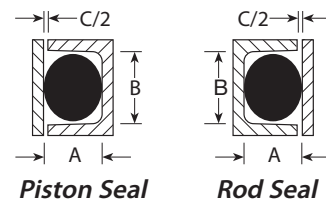

100 Series

Cantilever Spring Design

Cantilever Spring Energized Seals, Highly Dynamic Applications

Cantilever Spring Energized Seals (SES) are primarily used in highly dynamic applications for rotary and reciprocating equipment, but they can be used in static applications, when higher deflection springs are needed. The improved spring and seal deflection capability can be required due to excessive expansion or contraction, or wide hardware tolerance.

The 100 Series incorporates a U-shaped seal jacket with a high performance, stainless steel V-shaped cantilever spring to apply positive sealing force to the mating surface.

This design utilizes an asymmetric seal profile, where the dynamic lip has a robust profile in combination with a front angle, providing excellent leakage control and good scraping effect in case of highly viscous medias. The V-shaped cantilever spring design provides the spring tension at the leading edge of the seal only, which helps to optimize lip load and minimize frictional force.

Seal jackets are made from high performance fluoroplastic compounds and engineered plastics that provide, low coefficient of friction, high abrasion resistance, dimensional stability, and outstanding resistance to most fluids, chemicals, and gases.

This is the most popular spring energized seal design series due to its unique attributes, which help to maximize seal and hardware life.

The 100 Series is available in different unique jacket materials to address a broad range of applications.

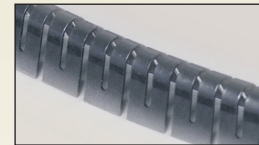
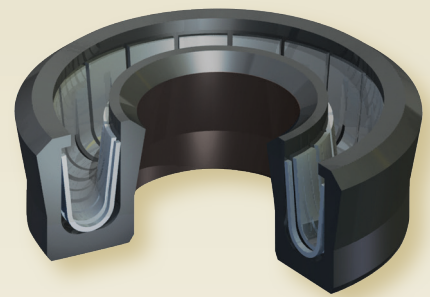

- Highly dynamic and static applications; plant-wide usage
- Unidirectional designs; available as rod, piston, flange, or static seals
- Single-point profile yields high sealability while minimizing frictional force
- All seals are made-to-order; no equipment modifications required
- Custom designs and materials available upon request

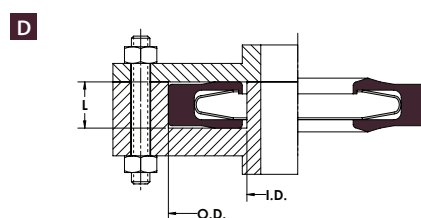
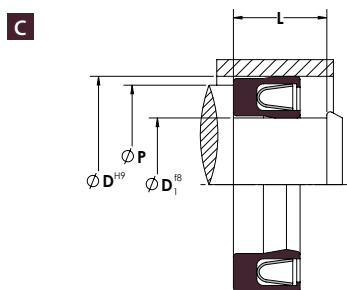
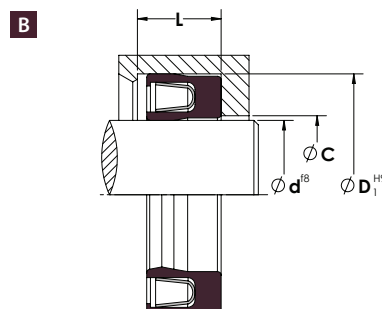
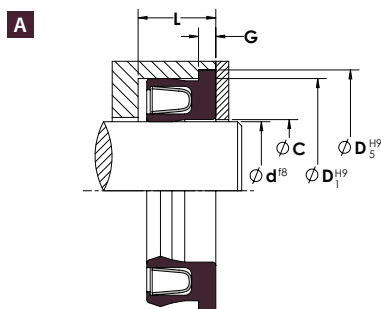

To place an order:

A

Product profile: _____

Material: _____

Rod shaft diameter (d): _____

Bore diameter (D₁): _____

Flange groove depth (G): _____

To place an order:

B

Product profile: _____

Material: _____

Rod shaft diameter (d): _____

Bore diameter (D₁): _____

Groove height (L): _____

100 Series

Cantilever Spring Design



SPECIFICATIONS

Material (designation)	Temperature °C (°F)
AWC300 (PTFE) Moly & Glass	-156 – 204 (-250 – 400)
AWC400 (PTFE) Carbon and Graphite	-156 – 204 (-250 – 400)
AWC510 (PTFE) Mineral Filled FDA	-156 – 204 (-250 – 400)
AWC520 (PTFE) Virgin Unfilled	-156 – 204 (-250 – 400)
AWC610 UHMWPE	-253 – 82 (-425 – 180)
AWC630 PEEK	-73 – 204 (-100 – 400)

PRODUCT PROFILES

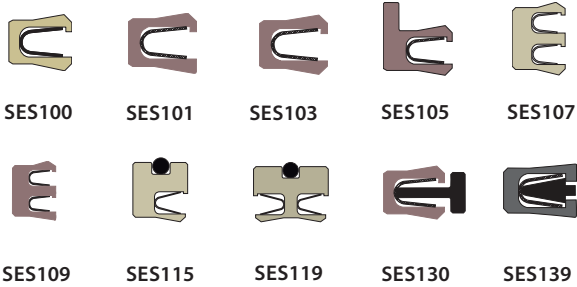

200 Series

Elliptical Coil Spring Design

Elliptical Coil Spring Energized Seals with Constant Lip Load

Elliptical Coil Spring Energized Seals (SES) are commonly used in rotary, reciprocating, and static applications, where constant lip load or constant friction for low-pressure applications is needed. The elliptical coil spring provides an almost constant load on seal lips independent of hardware tolerances, eccentricity, and seal wear.

The 200 Series incorporates a U-shaped seal jacket with a high performance, stainless steel elliptical coil spring with high spring loading, which provides excellent sealing at zero or low system pressure, even in the case of fluid and gas applications.

Seal jackets are made from high performance fluoroplastic compounds and engineered plastics that provide a low coefficient of friction, high abrasion resistance, dimensional stability, and outstanding resistance to most fluids, chemicals, and gases as well as a resistance to aging.

The 200 Series is available in six unique jacket materials to address a broad range of applications. Each seal jacket is used in combination with a high performance, stainless steel elliptical coil spring to apply positive sealing force to the mating surface.

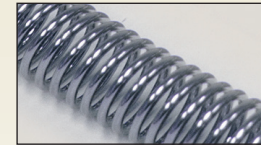
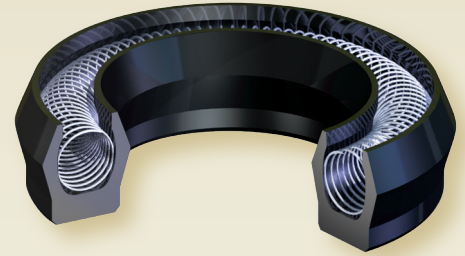

- Unidirectional design accommodates excessive tolerances or misalignment
- Elliptical coil spring design; high load vs. deflection
- Miniature profiles accommodate small diameters
- All seals are made-to-order; no equipment modifications required
- Custom designs and materials available upon request

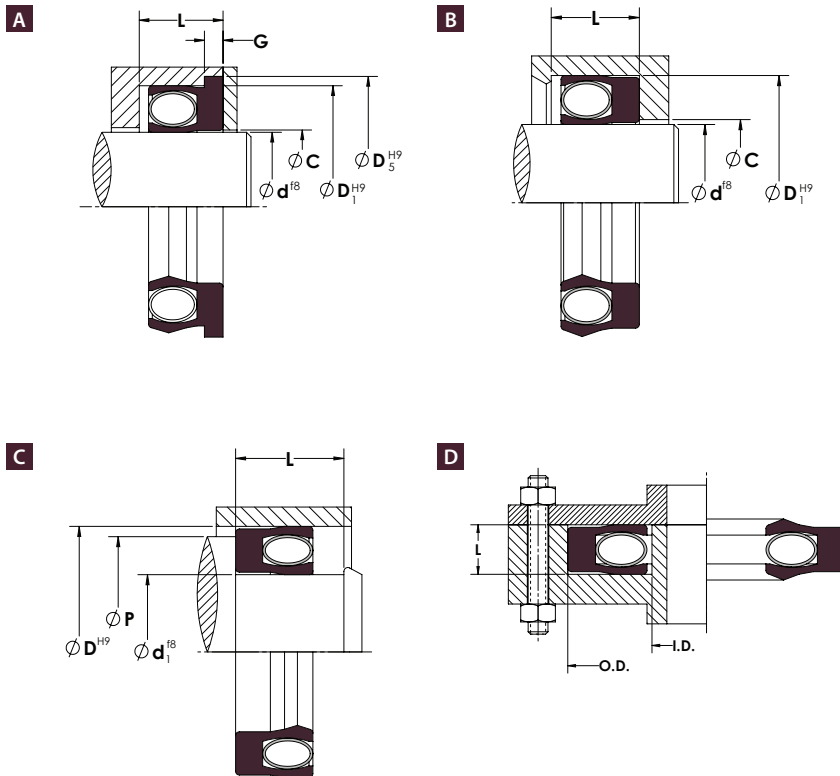

200 Series

Elliptical Coil Spring Design



SPECIFICATIONS

Material (designation)	Temperature °C (°F)
AWC300 (PTFE) Moly & Glass	-156 – 204 (-250 – 400)
AWC400 (PTFE) Carbon and Graphite	-156 – 204 (-250 – 400)
AWC510 (PTFE) Mineral Filled FDA	-156 – 204 (-250 – 400)
AWC520 (PTFE) Virgin Unfilled	-156 – 204 (-250 – 400)
AWC610 UHMWPE	-253 – 82 (-425 – 180)
AWC630 PEEK	-73 – 204 (-100 – 400)

PRODUCT PROFILES



SES200

SES204

SES205

To place an order: A

Product profile: _____
 Material: _____
 Rod shaft diameter (d): _____
 Bore diameter (D_i): _____
 Flange groove depth (G): _____

To place an order: C

Product profile: _____
 Material: _____
 Groove diameter (d): _____
 Bore diameter (D_i): _____
 Groove height (L): _____
 Piston diameter (P): _____

To place an order: B

Product profile: _____
 Material: _____
 Rod shaft diameter (d): _____
 Bore diameter (D_i): _____
 Groove height (L): _____

To place an order: D

Product profile: _____
 Material: _____
 Inner diameter (I.D.): _____
 Outer diameter (O.D.): _____
 Groove height (L): _____

300 Series

Helical Wound Spring Design

Helical Wound Spring Energized Seals for Slow Speed and Static Applications

Helical Wound Spring Energized Seals (SES) are primarily used in static applications, slow speeds, extremely low temperatures, and/or infrequent dynamic conditions when friction and wear are secondary concerns. The spring design has excellent loading capabilities with minimal deflection.

The 300 Series incorporates a U-shaped seal jacket with a high performance, stainless steel helical wound spring that produces very high load versus lip deflection. The helical wound spring provides evenly distributed load on each individual band of the spring. As the gaps are very small between the coils, the spring creates near continuous load around the interference of the seal, thus significantly reducing potential leak paths. This is why 300 Series seals are well-suited for zero or low system pressure, vacuum, and cryogenic applications.

Seal jackets are made from high performance fluoroplastic compounds and engineered plastics that provide high abrasion resistance, dimensional stability, and outstanding resistance to most fluids, chemicals, and gases as well as a resistance to aging.

The 300 Series is available in three unique jacket materials to address a broad range of applications. Each seal jacket is used in combination with a high performance, stainless steel elliptical coil spring to apply positive sealing force to the mating surface.

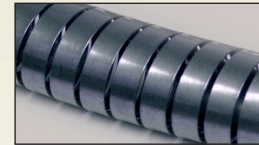
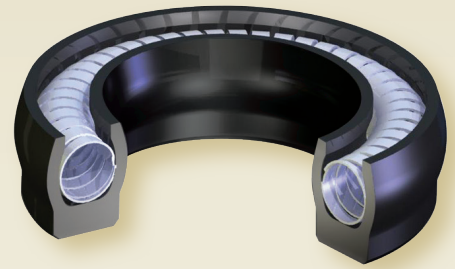

- Unidirectional design for slow speed and static applications
- Helical wound spring design; high load, minimal deflection
- Concentrated load design when friction and wear are secondary concerns
- All seals are made-to-order; no equipment modifications required
- Custom designs and materials available upon request

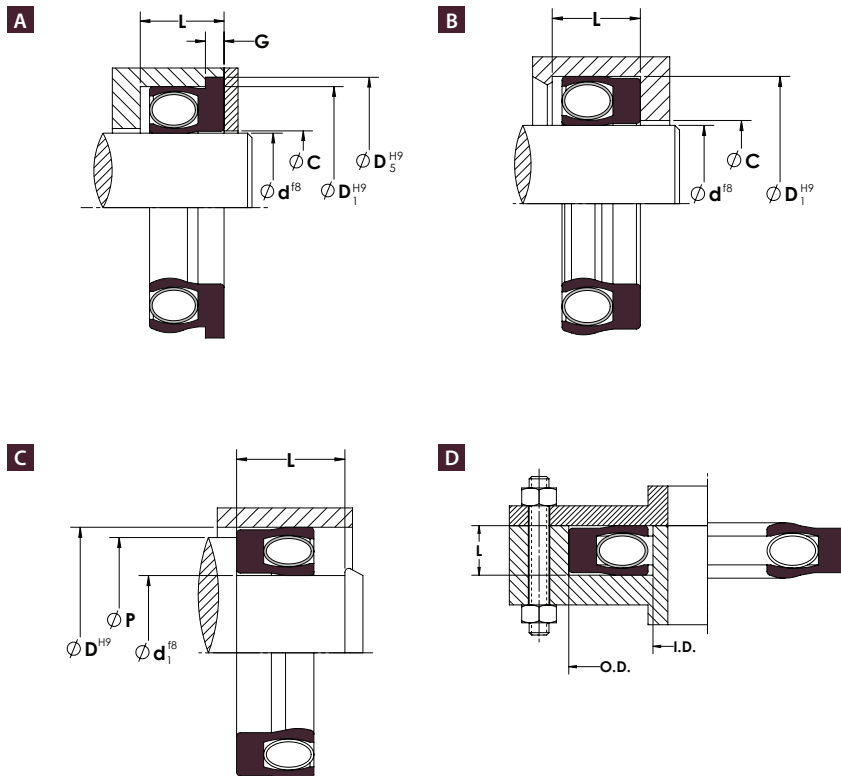

300 Series

Helical Wound Spring Design



SPECIFICATIONS

Material (designation)	Size Range* mm (inch)	Temperature °C (°F)
AWC400 (PTFE) Carbon and Graphite	1.2 – 2032 (0.050 – 80)	-156 – 204 (-250 – 400)
AWC630 PEEK	1.2 – 254 (0.050 – 10)	-73 – 204 (-100 – 400)
AWC610 UHMWPE	1.2 – 2032+ (0.050 – 80+)	-253 – 82 (-425 – 180)

*Please contact your Chesterton representative for larger sizes.

PRODUCT PROFILES



SES300



SES304



SES305

To place an order:

A

Product profile: _____
 Material: _____
 Rod shaft diameter (d): _____
 Bore diameter (D_i): _____
 Flange groove depth (G): _____

To place an order:

C

Product profile: _____
 Material: _____
 Groove diameter (d): _____
 Bore diameter (D_i): _____
 Groove height (L): _____
 Piston diameter (P): _____

To place an order:

B

Product profile: _____
 Material: _____
 Rod shaft diameter (d): _____
 Bore diameter (D_i): _____
 Groove height (L): _____

To place an order:

D

Product profile: _____
 Material: _____
 Inner diameter (I.D.): _____
 Outer diameter (O.D.): _____
 Groove height (L): _____

500 Series

Stacked V-Ring Seals

High Performance, Multi-purpose R-ring Sets

High performance, multi-purpose stacked V-Ring sets are ideal for demanding applications, where the reliability and seal performance are requirements. The 500 series can accommodate hardware with deep stuffing boxes. These stacked sets are used in both rotary and reciprocating applications and are available in solid and split designs, depending upon application requirements.

A typical 500 Series V-Ring set is comprised of female and male gland adapters (for supporting and energizing functions) and three to five sealing rings, depending on operating conditions and equipment hardware configuration. The gland pressure (energizing axial force) is transferred between the seal rings, pressurizing them and creating optimal, positive contact to the counter surfaces.

Other 500 Series sets incorporate a gland adapter ring, several seal rings (V-Rings), and a radial Spring Energized Seal (SES) ring. The radial SES ring is the primary sealing element. When it is pressurized by the system pressure, it activates the V-Rings by pushing against the gland adapter ring. The multiple seal edges reduce the risk of a potential leak path. The gland adapter ring provides support to the entire seal set and protects against extrusion.

The 500 Series is available in several unique materials to address a broad range of applications, where chemical compatibility with media, high or low operating temperature, or high speed (fast reciprocating movements) make the application challenging to the seals.

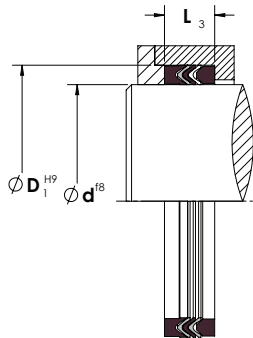

SPECIFICATIONS

Material (designation)	Temperature °C (°F)
AWC300 (PTFE) Moly & Glass	-156 – 204 (-250 – 400)
AWC400 (PTFE) Carbon and Graphite	-156 – 204 (-250 – 400)
AWC510 (PTFE) Mineral Filled FDA	-156 – 204 (-250 – 400)
AWC520 (PTFE) Virgin Unfilled	-156 – 204 (-250 – 400)
AWC610 UHMWPE	-253 – 82 (-425 – 180)
AWC630 PEEK	-73 – 204 (-100 – 400)

PRODUCT PROFILES



SES500

SES520

SES521

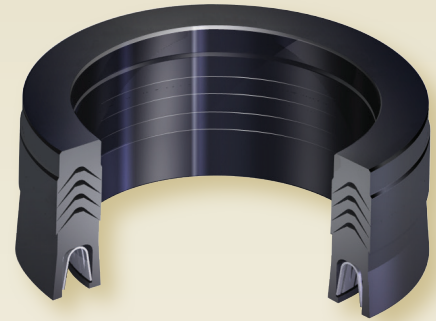

- Unidirectional design, which replaces V-Ring sets
- Multi-purpose V-Ring seal sets; plant-wide usage
- All seals are made-to-order; no equipment modifications required
- Custom profiles available
- V-Ring sets accommodate hardware with deep stuffing boxes

To place an order:

Product profile: _____

Material: _____

Rod shaft diameter (d): _____

Bore diameter (D₁): _____

Working height (L₃): _____

600 Series

Continuous Contact Seals

Heavy-duty, High Load Seals

Continuous Contact, robust Spring Energized Seals (SES) are primarily used where very high axial loading is required for challenging static and slow rotary, oscillating applications. This design is best utilized in difficult static sealing applications such as gas, cryogenic temperatures, and vacuum. This spring design can also be used in dynamic applications where high torque and clamping forces are present. The geometry of this spring lends itself to larger cross section and diameters.

The continuous spring is a U-shaped spring manufactured with independent grooves originating in the center of the ring and progressing to the outside diameter. This unique spring design produces a continuous, heavy load at the sealing points. The continuous geometry of the spring, when wound in a circumference, minimizes expansion and contraction due to thermal effects.

The SES Series 600 is available in multiple unique jacket materials to address a broad range of applications. Each seal jacket is used in combination with a high performance, metallic, continuous spring to produce the required high contact load for the positive sealing force against the mating surface.

The materials used for the 600 Series consist of high performance fluoroplastic compounds and engineered plastics that provide a low coefficient of friction, high abrasion resistance, and dimensional stability, as well as outstanding resistance to most fluids, chemicals, and gases.

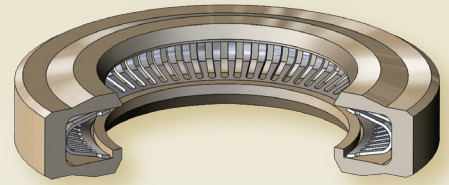

- Continuous contact, robust spring design for tight sealing
- Sealing solution for challenging static and rotary applications
- Ideal solution for large cross sections
- All seals are made-to-order; no equipment modifications required
- Custom profiles available

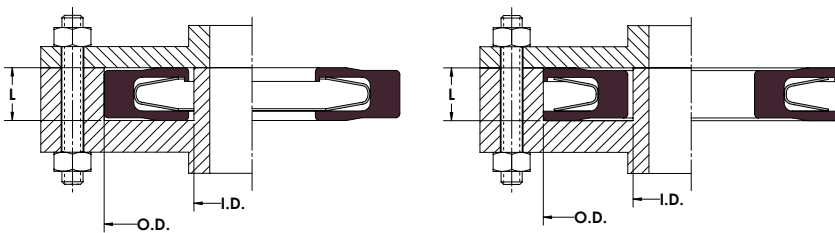

SPECIFICATIONS

Material (designation)	Temperature °C (°F)
AWC300 (PTFE) Moly & Glass	-156 – 204 (-250 – 400)
AWC400 (PTFE) Carbon and Graphite	-156 – 204 (-250 – 400)
AWC510 (PTFE) Mineral Filled FDA	-156 – 204 (-250 – 400)
AWC520 (PTFE) Virgin Unfilled	-156 – 204 (-250 – 400)
AWC610 UHMWPE	-253 – 82 (-425 – 180)
AWC630 PEEK	-73 – 204 (-100 – 400)

PRODUCT PROFILES



SES600

To place an order:

Product profile: _____

Material: _____

Internal diameter (ID): _____

Outside diameter (OD): _____

Working height (L): _____

Common Profiles

ROD SEALS

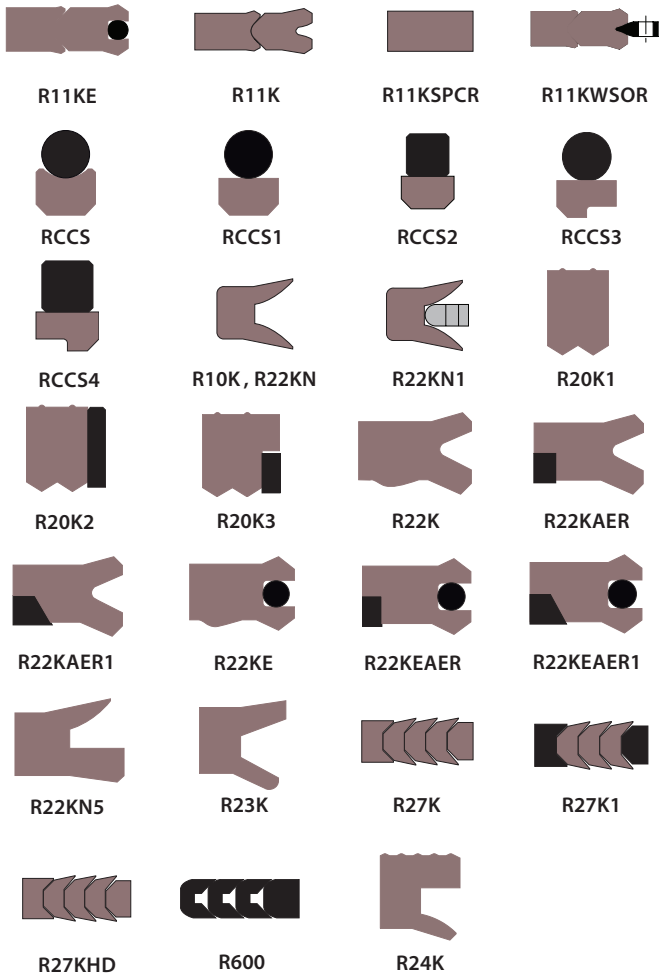

PISTON SEALS

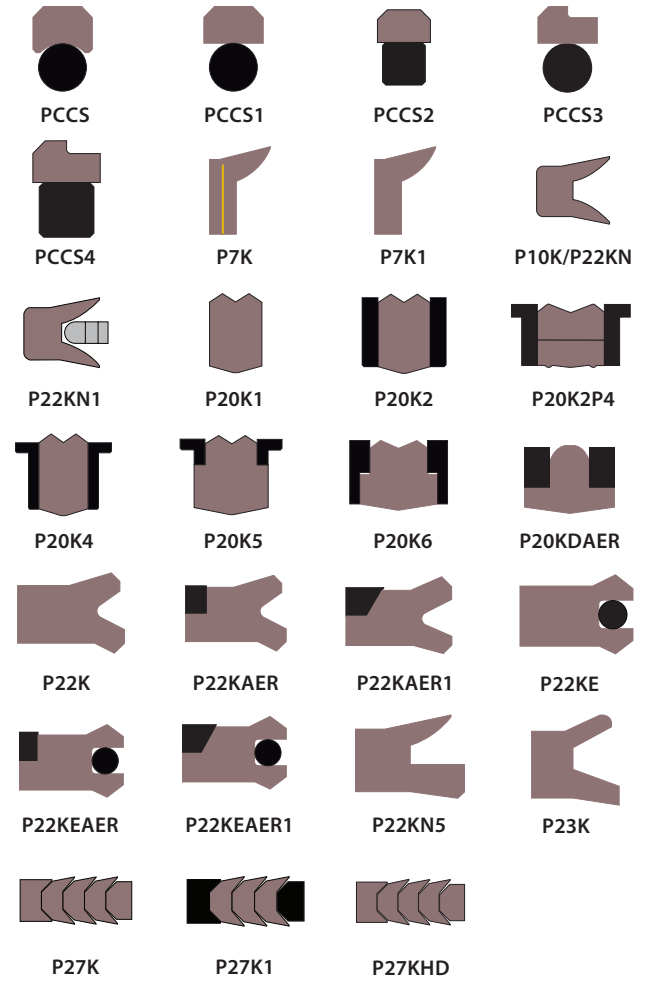

ANTI-EXTRUSION RINGS

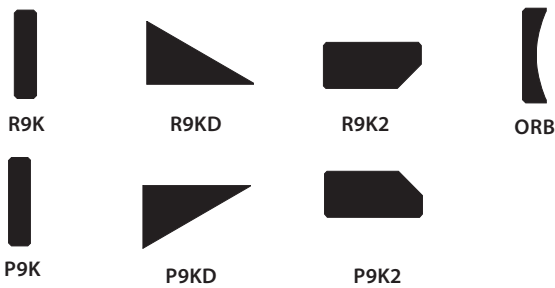

BEARING ELEMENTS

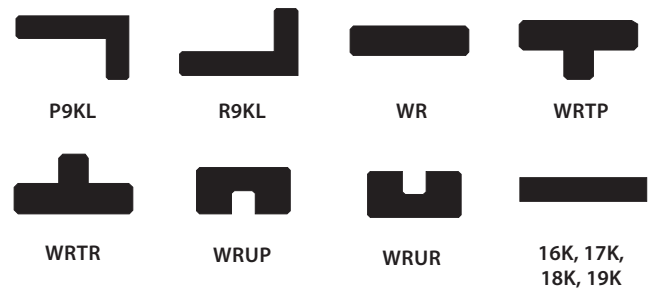

WIPERS

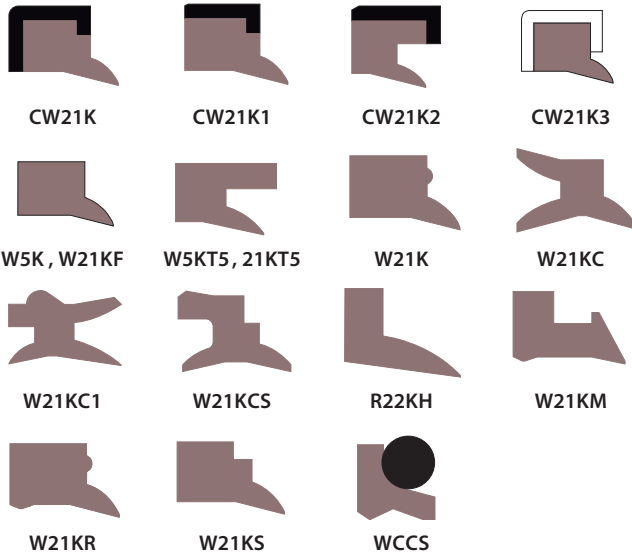

STATIC SEALS, O-RINGS

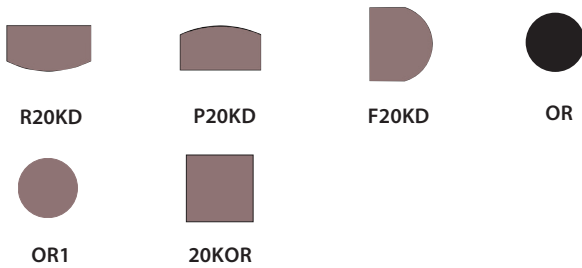

ROTARY/CUSTOM SEALS

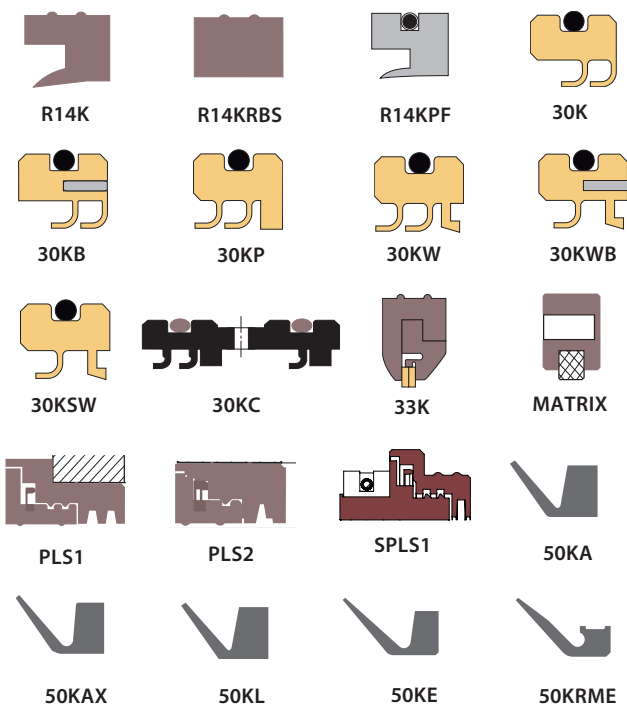

ROTARY/CUSTOM SEALS

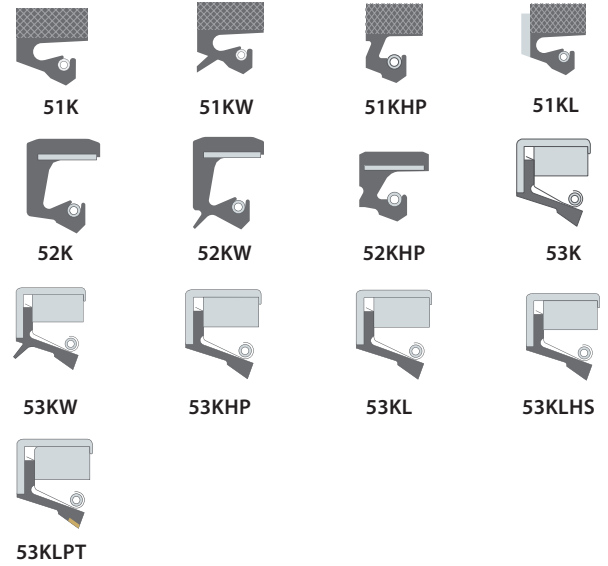

SPRING ENERGIZED SEALS



Profile Guide

Chesterton has more than a hundred profiles and geometries for seals used in different application conditions. For specific recommendations please contact your local Chesterton Engineering specialist.

Wipers

The function of a wiper is to effectively clean and dislodge foreign matter from a reciprocating rod/ram to minimize contaminants from entering the system.

21K STANDARD WIPER

Positive rake wipers designed to effectively clean and dislodge foreign matter from retracting rod/ram to protect against scoring and system contamination.

Profile	Description
W21KF	Wiper with flange design
W21KT5	Wiper to accommodate taller groove heights while providing added stability
W21K	Wiper with static bump flange design to eliminate migration of contaminants
W21KC	Combination wiper and rod seal; pneumatic use only
W21KC1	Wiper designed with snap-in fit for specific equipment types
W21KCS	Combination wiper and rod seal designed with stepped flange; pneumatic use only
W21KM	Wiper designed with snap-in fit for specific equipment types
W21KR	Wiper with static flange bump and stabilizing heel
W21KS	Wiper profile with stepped flange
WCCS	Wiper using an O-Ring loader for use with polyurethane or PTFE compounds



21K CANNED WIPERS

Positive rake, canned wipers designed to effectively clean and dislodge foreign matter from retracting rod/ram to protect against scoring and system contamination. A canned wiper is a press-fit design for use in an open housing groove and does require an additional retaining device due to the interference fit.

Profile	Description
CW21K	Dual-component, full canned stepped flange canned wiper design
CW21K1	Dual-component, partial stepped flange canned wiper design
CW21K2	Dual-component with taller static lip canned wiper design
CW21K3	Dual-component, full canned wiper design

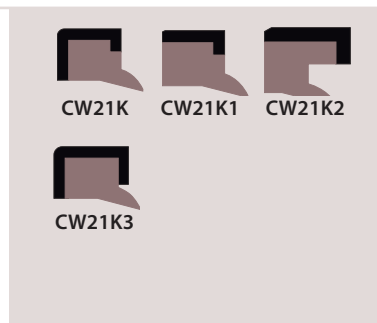

Rod Seals — U-Cups

The function of a rod seal is to protect against fluid bypass along the dynamic (rod /ram) and static (stuffing box bore) surfaces under various operating conditions. A U-Cup design refers to a continuous seal ring with a profile similar to the letter U.

22KN U-CUPS

A continuous, single-acting rod or piston seal U-Cup design that wipes contaminants away from the mating surface while in operation. The positive rake, lip profile provides an optimal amount of radial sealing load with minimal frictional resistance. It is designed for use in hydraulic or pneumatic applications.

Profile	Description
R22KN	Rod seal design for use in hydraulic or pneumatic cylinders and presses
R22KN1	Rod seal design with a standoff ring for vacuuming situations
R22KN5	Rod seal design with taller static lip for added stability and to resist vacuuming
R22KH	Rod seal with flange design; for replacement as a hat seal

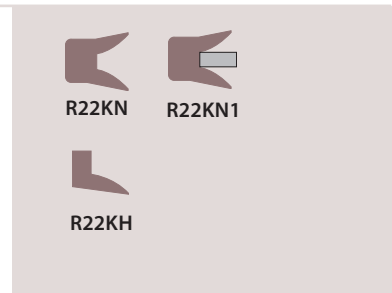

6K U-CUPS

A continuous, single-acting U-Cup design with a positive rake profile that wipes contaminants away from the mating surface while in operation. The rugged, rubber-based construction is ideal for older, worn hydraulic cylinders and presses, since it conforms to surface irregularities to effectively control leakage.

Profile	Description
R6K	Rod seal design for use in older, worn equipment



22K U-CUPS

A continuous, single-acting rod or piston hydraulic seal design with a special lip geometry that increases lip pre-load and provides zero leakage throughout the entire operating range. The sturdy, static lip stabilizes the seal to minimize rolling and the negative rake lip profile eases installation.

Profile	Description
R22K	Rod seal for hydraulic cylinders and presses
R22KAER	Rod seal that includes a partial, rectangular anti-extrusion ring for equipment exposed to excessive clearances and pressure spikes
R22KAER1	Rod seal that includes a custom anti-extrusion ring for equipment exposed to excessive clearances and pressure spikes

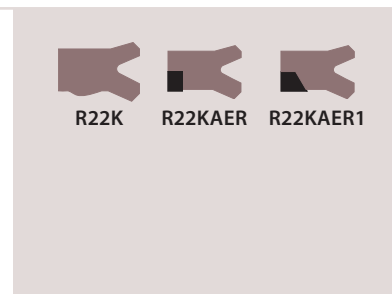

22KE U-CUPS

A continuous, single-acting, rod or piston design incorporates the use of an O-Ring to increase pre-load capabilities, which improves low-pressure sealing capabilities and high shock load capabilities in hydraulic applications. The O-Ring energizes the seal, which increases the pre-load capabilities of the seal in the absence of system pressure.

Profile	Description
R22KE	Rod seal with O-Ring energizer for hydraulic cylinders and presses
R22KEAER	Rod seal with O-Ring energizer that includes a partial, rectangular anti-extrusion ring for equipment exposed to excessive clearance and pressure spikes
R22KEAER1	Rod seal with O-Ring energizer that includes a partial, anti-extrusion ring for equipment exposed to excessive clearances and pressure spikes



23K U-CUPS

A continuous, single-acting rod or piston design that incorporates a unique, dynamic lip geometry that provides the optimal sealing force required for pneumatic applications.

Profile	Description
R23K	Continuous rod seal design



24K U-CUPS

A low-speed, low-pressure split rotary seal that has a flexible dynamic lip for large shaft runout and a positive rake lip design to wipe contaminants.

Profile	Description
R24K	Split rotary seal



Rod Seals — Stacked Sets

Stacked V-Ring seal designs are most commonly used to ensure ease of installation due to the split design, although in some cases continuous designs are preferred. These V-Ring sets incorporate sealer rings that are nested inside a female/top and a male/bottom adapter. The number of sealer rings used in a set is predicated upon system pressure. The male adapter is used to ensure alignment of the sealer rings while also helping to energize the set under system pressure. The female adapter is designed to ensure alignment and support of the set while helping to compensate for extrusion into large equipment clearances.

8K/27K/28K STACKED SETS

The rod and piston V-Ring sets are used in hydraulic applications. The single-acting, positive rake profile contacts through the center of the set to provide even loading and longer sealing life using minimal gland pressure. Most sets are available split or solid.

Profile	Description
R8K	Single-acting, symmetrical seal set; available split or solid
R27K	Single-acting, symmetrical seal set; available split or solid
R27K1	Single-acting, symmetrical seal set with adapters made from engineered plastics for added support and extrusion resistance
R28K	Single-acting, symmetrical seal set for replacement of typical industry sets
R28K1	Single-acting, symmetrical seal set with adapters made from engineered plastics for added support and extrusion resistance

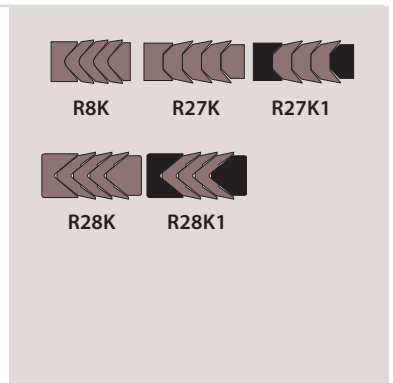

11K STACKED SETS

The single-acting, two-piece, stacked rod seal set employs a negative rake design to optimize operating performance and ease installation into the stuffing box cavity. The bottom ring is the primary sealer, while the top ring works as an anti-extrusion ring, and provides secondary sealing and added support to the sealer ring. The set is available in various material combinations as well as split or solid designs.

Profile	Description
R11K	Symmetrical seal for hydraulic applications
R11KSPCR	Custom spacer used with seal set to help compensate for vacuuming, side loading conditions, or shock loading conditions
R11KWSR	Single-acting, two-piece stacked set with a custom-designed spacer to help compensate for vacuuming conditions

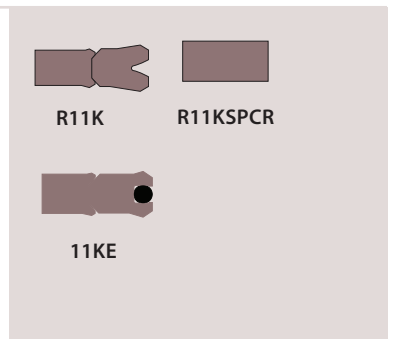

600 STACKED SETS

A single-acting, conventional compression stacked V-Ring set that enables increased seal loading against sealing surfaces with increased gland pressure, while the rubber-based material conforms to surface imperfections to control leakage. The set includes sealer rings and a bottom adapter.

Profile	Description
R600	Single-acting, conventional stacked design for older, worn equipment; available split or solid

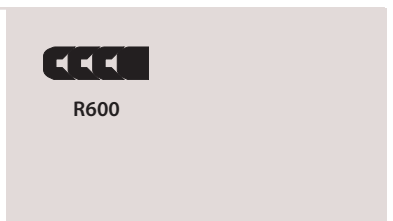

Rod Seals — Compression, Static

Compression-type seals are typically designed with a higher initial pre-load, which helps to control leakage at low pressure. These profiles are typically used in a single-cavity groove, but are able to seal pressure in both directions.

RCCS ROD—COMPRESSION SEALS

A continuous, two-piece, bidirectional sealing system that uses an elastomer cap with an O-Ring to create a very effective seal for single-groove cavities in hydraulic applications. The cap is used as the dynamic sealing element, while the O-Ring energizes the cap and creates a static seal.

Profile	Description
RCCS	Two-piece rod seal with an elliptical cap profile for more efficient loading in hydraulic applications
RCCS1	Two-piece rod seal with a standard profile for use in hydraulic applications
RCCS2	Two-piece rod seal with a rectangular loader for use in highly dynamic hydraulic applications
RCCS3	Two-piece rod seal with a stepped cap profile for use in hydraulic applications
RCCS4	Two-piece piston seal with a rectangular loader and a stepped cap profile for use in highly dynamic hydraulic applications

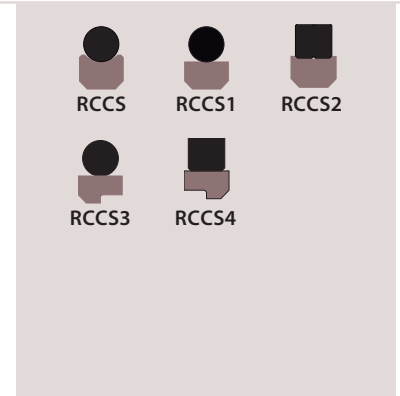

20K COMPRESSION

A continuous, bidirectional compression seal with dual independent sealing points. The heavy, durable, dual lip design is used for single-groove cavities in heavy-duty, high-pressure hydraulic applications. The seal has the ability to withstand pressure spikes while helping to compensate for equipment side loading and maintain high unit loading.

Profile	Description
R20K1	Heavy-duty rod seal for use in hydraulic applications
R20K2	Heavy-duty rod seal with full anti-extrusion ring
R20K3	Heavy-duty rod seal with partial anti-extrusion ring
R20KDAER	Heavy-duty rod seal with two partial anti-extrusion rings

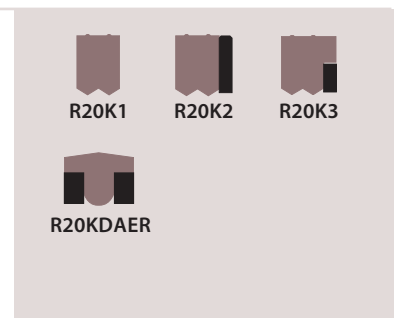

20KD STATIC/FACE

A continuous, high performance compression seal that is most commonly used in static applications and is often applied as an upgrade from conventional O-Rings. Designs are available for internal face sealing as well as external face sealing commonly found in single- or double-acting applications.

Profile	Description
R20KD	Seal, D-profile, and dynamic seal profile located on the inner diameter
F20KD	Profile for face sealing with the dynamic seal profile located on either the top or bottom
OR1	Seal for replacement of molded conventional O-Ring
20KOR	Rectangular seal for sealing static connecting ports of standard hydraulic valves and control units
OR	Individual standard model elastomer O-Ring

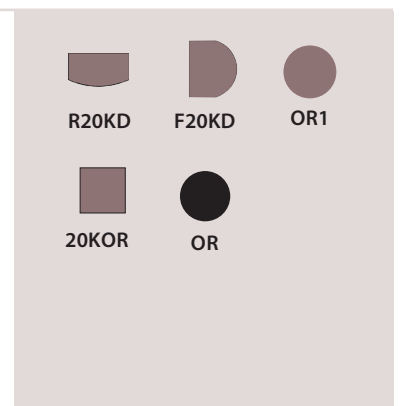

20KD PISTON MOUNTED – STATIC FACE

A continuous, high-performance compression seal that is most commonly used in static applications, and is often applied as an upgrade from conventional O-Rings. Designs are available for internal face sealing as well as external face sealing commonly found in single- or double-acting applications.

Profile	Description
P20KD	Seal profile with dynamic side located on the outer diameter
20KOR	Rectangular seal for sealing static connecting ports of standard hydraulic valves and control units

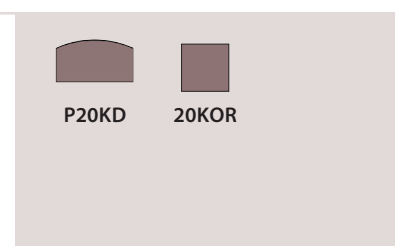

Piston Seals — U-Cups

The function of a piston seal is to protect against fluid bypass between the piston head and cylinder bore under various operating conditions.

22KN U-CUPS

A continuous, single-acting, rod or piston seal, U-Cup design that wipes contaminants away from the mating surface while in operation. The positive rake, lip profile provides an optimal amount of radial sealing load with minimal frictional load. It is used in hydraulic or pneumatic applications.

Profile	Description
P22KN	Piston seal design for use in hydraulic or pneumatic cylinders and presses
P22KN1	Piston seal design with a standoff ring for vacuuming situations
P22KN5	Piston seal design with taller static lip for added stability and to resist vacuuming



22K U-CUPS

A continuous, single-acting, rod or piston hydraulic seal design with a special lip geometry that minimizes leakage throughout the entire operating range. The sturdy, static lip stabilizes the seal to protect against rolling, while the negative rake lip profile eases installation.

Profile	Description
P22K	Piston seal for hydraulic cylinders and presses
P22KAER	Piston seal that includes a partial, rectangular anti-extrusion ring for equipment exposed to excessive clearances and pressure spikes
P22KAER1	Piston seal that includes a custom anti-extrusion ring for equipment exposed to excessive clearances and pressure spikes



22KE U-CUPS

A continuous, single-acting, rod or piston design incorporates the use of an O-Ring to increase pre-load capabilities for extreme low-pressure sealing capabilities in hydraulic applications.

Profile	Description
P22KE	Piston seal with O-Ring energizer for hydraulic cylinders and presses
P22KEAER	Piston seal with O-Ring energizer that includes a partial, rectangular anti-extrusion ring for equipment exposed to excessive clearance and pressure spikes
P22KEAER1	Piston seal with O-Ring energizer that includes a custom anti-extrusion ring for equipment exposed to excessive clearances and pressure spikes



23K U-CUPS

A continuous, single-acting, rod or piston design incorporating a unique, dynamic lip geometry that provides the optimal sealing force required for pneumatic applications.

Profile	Description
P23K	Continuous piston seal design



Piston Seals — Stacked Sets

Stacked V-Ring seal designs are most commonly used to ensure ease of installation due to the split design. The sealer rings are nested inside a female/top and a male/bottom adapter. The male adapter centers the sealer rings while also energizing the set under system pressure. The female adapter supports the set and helps compensate for extrusion into large equipment clearances.

8K/27K/28K STACKED SETS

These pressure-activated rod and piston V-Ring sets are used in hydraulic applications. The single-acting, positive rake profile contacts through the center of the set to provide even loading, and longer sealing life using minimal gland pressure. Most sets are available split or solid.

Profile	Description
P8K	Single-acting, symmetrical seal set; available split or solid
P27K	Single-acting, symmetrical seal set; available split or solid
P27K1	Single acting, symmetrical seal set with adapters made from engineered plastics for added support and extrusion resistance
P28K	Single-acting, symmetrical seal set for replacement of typical industry sets
P28K1	Single acting, symmetrical seal set with adapters made from engineered plastics for added support and extrusion resistance

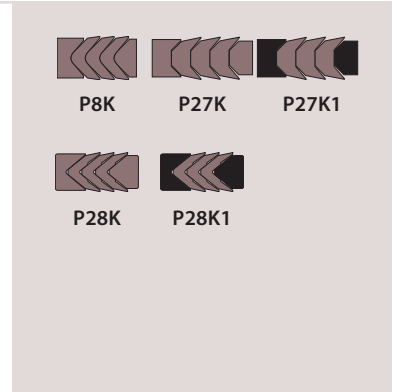

11K STACKED SETS

The single-acting, two-piece stacked piston seal set employs a negative rake design to optimize operating performance and ease installation into the piston head seal cavity. The bottom ring is the primary sealer, while the top ring works as an anti-extrusion ring, and provides secondary sealing and added support to the sealer ring. The set is available in various material combinations. Only solid design is available.

Profile	Description
P11K	Symmetrical seal for hydraulic applications
P11KWSOR	Symmetrical seal with standoff ring for hydraulic applications

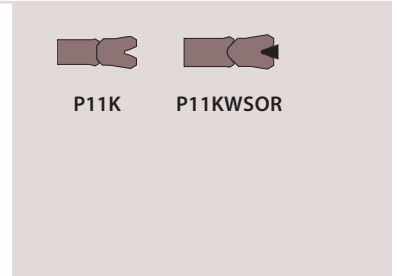

Piston Seals — Compression

CCS COMPRESSION

A continuous, two-piece, bidirectional sealing system that uses an elastomer cap with an O-Ring to create a very effective seal for single-groove cavities in hydraulic applications. The cap is used as the dynamic sealing element, while the O-Ring energizes the cap and creates a static seal.

Profile	Description
PCCS	Two-piece, piston seal with an elliptical cap profile for more efficient loading in hydraulic applications
PCCS1	Two-piece, piston seal with a standard profile for use in hydraulic applications
PCCS2	Two-piece, piston seal with a rectangular loader for use in highly dynamic hydraulic applications
PCCS3	Two-piece, piston seal with a stepped cap profile for use in hydraulic applications
PCCS4	Two-piece, piston seal with a rectangular loader and a stepped cap profile for use in highly dynamic hydraulic applications

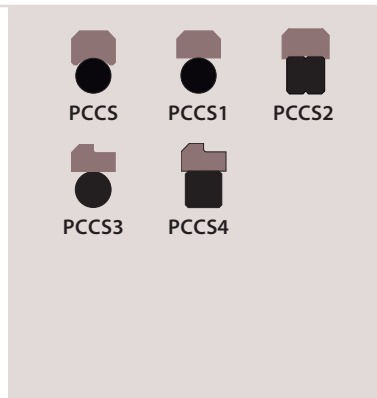

20K COMPRESSION

A continuous, bidirectional compression seal with dual independent sealing points. The seal design has the ability to withstand pressure spikes while helping to compensate for equipment side loading.

Profile	Description
P20K1	Heavy-duty piston seal for use in hydraulic applications
P20K2	Heavy-duty, bidirectional piston seal with two full anti-extrusion rings
P20K3	Heavy-duty piston seal with two partial anti-extrusion rings
P20K4	Heavy-duty piston seal with two full L-shaped anti-extrusion rings
P20K5	Heavy-duty piston seal with two partial L-shaped anti-extrusion rings
P20K6	Heavy-duty piston seal with two stepped anti-extrusion rings
P20KDAER	Heavy-duty piston seal with two sturdy rectangular anti-extrusion rings
P20K2P4	Heavy-duty, 4-piece piston seal with two full L-shaped anti-extrusion rings

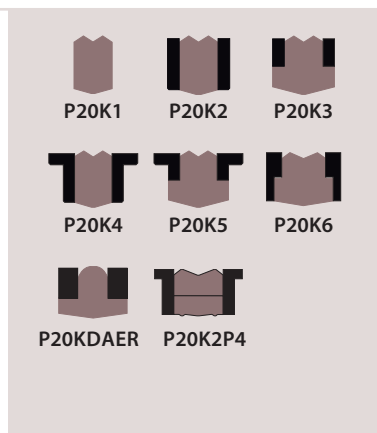

7K PISTON CUP

The single-acting piston cup has a positive, flared lip design to optimize sealing forces. The design is supplied with a supporting, metallic brass disc molded into the base of the seal to minimize over compression of the flange and improve seal performance. The resulting rigid base provides a stable, non-distorting, anti-extrusion-resistant seal. These can also be used back-to-back for double-acting applications.

Profile	Description
P7K	Piston cup seal design with built-in supporting metallic brass disc in the base to improve stability and anti-extrusion resistance
P7K1	Piston cup seal design (does not include a built-in brass disc)

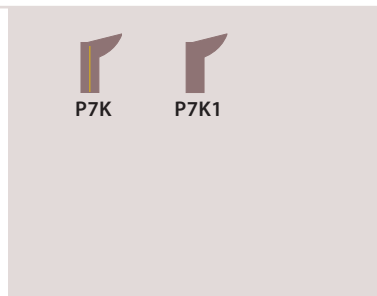

Ancillary Devices — Anti-Extrusion Rings (AER)

9K ANTI-EXTRUSION RINGS (AER)

Anti-extrusion rings, sometimes referred to as backup rings, protect seals from extruding into equipment clearances while under pressure. Used in conjunction with a seal or O-Ring, they are available in various extrusion-resistant materials and are located on the low-pressure side, of the sealing element they are supporting.

Profile	Description
R9K	Rectangular profile, rod design
R9KD	Triangular profile used with rod seal
R9K2	Custom profile designed for distinct rod seal design
P9KD	Triangular profile used with distinct piston seal design
P9K2	Custom profile used with distinct piston seal design
ORB	Custom profile used in combination with an O-Ring
P9K	Rectangular profile, piston design

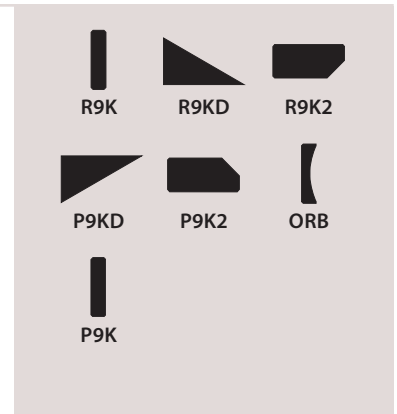

16K, 17K HYDRAULIC WEAR RING STRIPS

Wear ring strips are the economical solution to costly cylinder re-machining and repairs, and are suitable for use on rams or pistons in reciprocating applications. These split, replaceable wear rings minimize metal-to-metal contact of moving parts and help prolong equipment life.

The 16K Metric Bearing Band Strips are the solution to costly cylinder re-machining and repairs for large diameter equipment. The bearing material is made from a thermoset polyester resin reinforced with synthetic fabric specifically designed to support heavy loads. The exceptional physical properties and built-in PTFE lubricants make these bearing band strips suitable for use on rams or pistons in reciprocating applications.

The 17K Imperial Bearing Band Strips are the solution to costly cylinder re-machining and repairs for large diameter equipment. The bearing material is made from a composite of polyester resin reinforced with synthetic fibers specifically designed to support heavy loads. The exceptional physical properties and built-in graphite lubricants make these bearing band strips suitable for use on rams or pistons in reciprocating applications.

Profile	Description
16K	Continuous coil form for metric sizes used for rod and piston applications
17K	Continuous coil form for inch sizes used for rod and piston applications

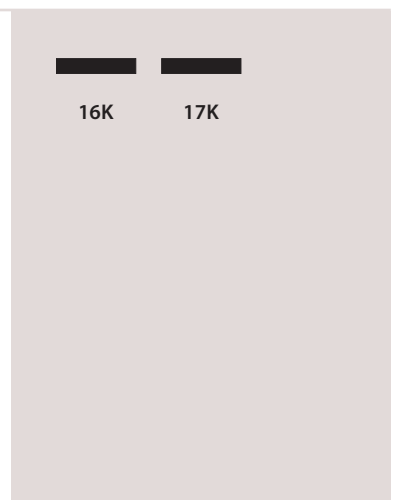

18K/19K/ WR WEAR RINGS

Wear rings are the solution to costly cylinder re-machining and repairs for hydraulic or pneumatic equipment. These split, replaceable wear rings minimize metal-to-metal contact of moving parts and help prolong equipment and seal life. These wear rings reduce radial movement, which extends seal life and reduces the risk of recurring damage.

Profile	Description
18K	Imperial sized wear rings for use in medium- and heavy-duty rod and piston applications; made from glass fiber-reinforced, heat-stabilized nylon
19K	Metric-sized wear rings for use in medium- and heavy-duty rod and piston applications; made from glass fiber-reinforced, heat-stabilized nylon
WR	Custom sized wear rings for use in light- to medium-duty rod and piston applications; available in various engineered plastics
R9KL	L-shaped wear rings for use in light- to medium- duty rod applications; available in various engineered plastics
P9KL	L-shaped wear rings for use in light- to medium-duty piston applications; available in various engineered plastics
WRTP	T-shaped wear rings for use in light- to medium-duty piston applications; available in various engineered plastics
WRUP	U-shaped, contoured wear rings for use in light- to medium-duty piston applications; available in various engineered plastics
WRUR	U-shaped wear rings for use in light- to medium-duty rod applications; available in various engineered plastics
WRTR	T-shaped wear rings for use in light- to medium-duty rod applications; available in various engineered plastics

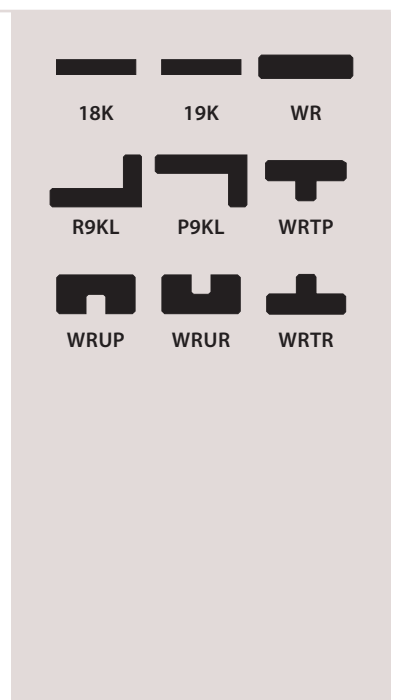

Rotary Seals

R24K BEARING AND GEARBOX PROTECTION

R24K rotary seals, with their robust design, are ideal for low-speed, dynamic rotary seal applications exposed to large shaft runout. These seals provide excellent sealing and protective solutions for heavy-duty rotating equipment, and help to prolong bearing and equipment service life, even in severe application conditions.



R24K

Profile	Description
R24K	Rotary seals for protection of housing and bearing areas in low-speed applications

33K BEARING AND GEARBOX PROTECTION

High performance, split lip seals with improved performance over conventional rotary lip seals in bearing and gearbox applications. The split design minimizes the need for equipment disassembly, and installation time can be reduced from hours to minutes. This seal is available in various PTFE-filled materials with polymer adapters.



33K

Profile	Description
33K	Split seal for use in high- or low-speed rotary applications

30K BEARING AND GEARBOX PROTECTION

High performance, continuous seals that with improved performance over conventional rotary lip seals in bearing and gearbox applications. These designs are available in various filled PTFE materials, which offer higher speeds, a wider temperature range, greater chemical compatibility, and longer life.

Profile	Description
30K	Continuous, dual lip replacement seal for high- or low-speed rotary applications
30KW	Continuous, dual lip replacement seal with built-in wiper design for high- or low-speed rotary applications
30KSW	Continuous, single lip replacement seal with built-in wiper design with limited space for high- and low-speed rotary applications
30KB	Continuous, dual lip replacement seal with metallic stabilizing band for high- and low-speed rotary applications
30KWB	Continuous, dual lip replacement seal with built-in wiper and metallic stabilizing band for high- and low-speed rotary applications
30KP	Continuous, dual lip replacement seal with built-in lip support ring for high-pressure rotary applications

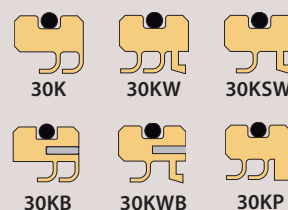

50K BEARING AND GEARBOX PROTECTION

50K face seals are high performance face seals that are used in heavy-duty, dynamic rotary seal applications. These seals protect against ingress of solid particles, dust, and fluids thus protecting housing and bearing areas. The 50K is used as a secondary seal for additional protection in combination with other Chesterton rotary seals, which are in the primary seal position.

Profile	Description
50KA	Rotary face seals with cross section profile that varies according to shaft diameter
50AX	Rotary face seal with longer lip for heavy duty applications
50KL	Rotary face seal with narrow axial cross section fit to compression arrangements
50KE	Rotary face seal with special lip for high performance sealing
50KRME	Rotary face seal with built-in housing for radial retention metal clamp



Rotary Seals

51K BEARING AND GEARBOX PROTECTION

51K seals are high performance radial seals used in heavy-duty, dynamic rotary seal applications. These seals provide long-lasting sealing and superior protection against ingress of solid particles, dust, and fluids, and protect bearing houses and gearboxes across the heavy industries, even in the most hostile working environments.

Profile	Description
51K	Large diameter, rotary seals with fabric reinforced back in solid and split form
51KW	Large diameter, rotary seals with fabric reinforced back and a special lip profile to withstand high pressure up to 0.40 MPa (60 psi); solid form only
51KHP	Large diameter, rotary seals with fabric reinforced back and additional circumferential groove for lubrication
51KL	Large diameter, rotary seals with fabric reinforced back and additional dust lip in solid and split form

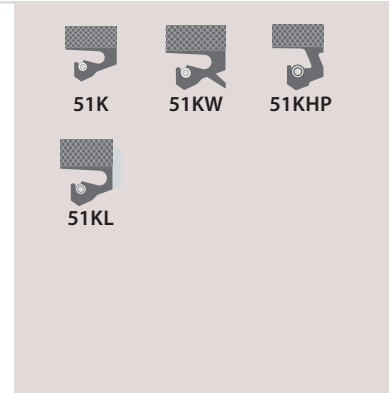

52K BEARING AND GEARBOX PROTECTION

52K seals are high performance radial seals used in heavy-duty, dynamic rotary seal applications. These seals provide long-lasting sealing and superior protection against ingress of solid particles, dust, and fluids, and protect bearing houses and gearboxes across the heavy industries, even in the most hostile working environments.

Profile	Description
52K	Large diameter, rotary seals with flexible metal stiffener ring in solid form only
52KW	Large diameter, rotary seals with special lip profile to withstand high pressure up to 0.40 MPa (60 psi)
52KHP	Large diameter, rotary seals with additional dust lip



53K BEARING AND GEARBOX PROTECTION

53K seals are high performance radial seals that are used in heavy-duty, dynamic rotary seal applications. These seals provide long-lasting sealing and protective solutions that withstand high speed and large misalignment of shafts and rolls in heavy industry.

Profile	Description
53K	Large diameter, rotary seals with garter-finger spring system
53KW	Large diameter, rotary seals with special, optimized lip interference for high-speed applications
53KHP	Large diameter, rotary seals with special, optimized lip interference for ultra-high-speed applications
53KL	Large diameter, rotary seals with garter-finger spring system and additional dust lip
53KLHS	Large diameter, rotary seals with integrated (vulcanized) PTFE lip tip
53KLPT	Large diameter, rotary seals with garter-finger spring system and special, robust lip profile to withstand high pressure up to 0.10 MPa (15 psi)



Rotary Seals

30KC POWDERS AND VISCOUS FLUIDS

A high performance, polymer cartridge seal for use in dynamic rotary seal applications. This cartridge design uses high performance, filled PTFE materials proven to withstand the high shear rates, frictional heat, and abrasives common when pumping high-viscosity products and powders.

Profile	Description
30KC	Cartridge design for sealing powders and viscous fluids
30KP	Continuous, dual lip replacement seal with built-in lip support ring for high-pressure rotary applications

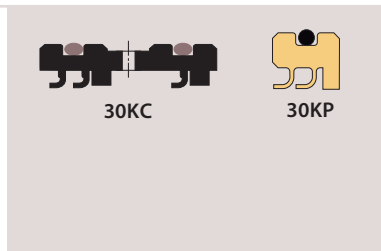

14K RESTRICTION BUSHING

Restriction bushings are used in rotary equipment to form a barrier between the sealing device in the stuffing box or pump impeller housing and the pump medium. The bushing helps to minimize suspended abrasive particles from entering the stuffing box area and reduces flush requirements. Individually manufactured from various materials, these restriction bushings provide excellent performance in pumps, agitators, mixers, refiners, and other equipment.

Profile	Description
R14K	Polymer restriction bushing for use in rotary applications
R14KRBS	Polymer spacer used in deep stuffing boxes
R14KPF	Virgin PTFE restriction bushing for use in rotary applications and with aggressive fluids



14KLR STUFFING BOX SOLUTIONS

14KLR lantern rings are used in rotating equipment to improve lubrication and cooling for packing rings and lip seals by distributing the liquid uniformly around the circumference of the shaft where external lubrication is utilized. A further function of the lantern rings is to keep abrasives and chemicals flushed.

Profile	Description
14KLR	Lantern ring, solid, split or half-ring versions for pump, agitators, mixers, refiners, and other equipment stuffing boxes



Spring Energized Seals

100 SERIES CANTILEVER DESIGN

Cantilever spring energized seals are primarily used in highly dynamic applications for rotary and reciprocating equipment, because the spring design allows for high deflection with minimal loading. This is the most popular spring energized seal design series due to its unique attributes, which help to maximize seal and hardware life.

Profile	Description
SES100	Symmetrical U-Cup seal for rod and piston applications
SES101	U-Cup rod seal with a positive rake profile on the dynamic lip
SES103	Symmetrical U-Cup face seal
SES105	Symmetrical, flanged, U-Cup rod seal for reciprocating and rotary equipment; flange minimizes seal rotation
SES107	U-Cup piston seal specifically for large cross sections
SES109	U-Cup rod seal specifically for large cross sections
SES115	U-Cup rod and piston seal for low-pressure, reciprocating, and rotary equipment
SES119	U-Cup piston seal for low-pressure, reciprocating, and rotary equipment
SES130	U-Cup rod and piston seal with support ring for added stability of seal
SES139	U-Cup rod and piston seal to separate media from spring

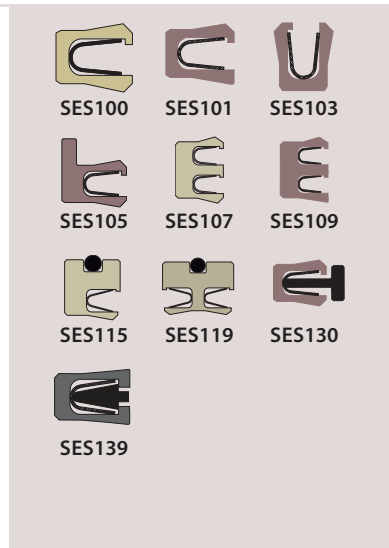

200 SERIES ELLIPTICAL DESIGN

Elliptical coil spring energized seals are commonly used in rotary, reciprocating, and static applications, where hardware tolerances are relatively large or where a miniature seal is required. The elliptical coil spring design allows for minimal deflection while applying intermediate loads.

Profile	Description
SES200	Symmetrical U-Cup seal with a standard lip profile
SES204	Symmetrical face seal with a standard lip profile, designed to seal on the inside diameter
SES205	Symmetrical, flanged U-Cup rod seal for reciprocating and rotary applications; flange minimizes seal rotation



300 SERIES HELICAL DESIGN

Helical wound spring energized seals are primarily used in static applications, slow speeds, extremely low temperatures, and/or infrequent dynamic conditions when friction and wear are secondary concerns. The spring design has excellent loading capabilities with minimal deflection.

Profile	Description
SES300	Symmetrical, U-Cup seal with a standard lip profile
SES304	Symmetrical, face seal with a standard lip profile to seal on the inside diameter
SES305	Symmetrical, flanged U-Cup rod seal for reciprocating and rotary applications; flange minimizes seal rotation



Spring Energized Seals

500 SERIES STACKED SETS

High performance, multi-purpose, stacked V-Ring sets to accommodate hardware with deep stuffing boxes. These stacked sets are used in both rotary and reciprocating applications and are available in solid and split designs, depending upon your application requirements.



Profile	Description
SES500	Symmetrical V-Ring set, for deep stuffing boxes; split or solid
SES520	Symmetrical, solid V-Ring set with spring-loaded primary seal ring for deep stuffing boxes
SES521	Symmetrical, solid V-Ring set with spring-loaded primary seal ring and stabilizer ring for deep stuffing boxes

600 SERIES CONTINUOUS CONTACT SPRING DESIGN

Continuous contact, robust, spring energized seals are primarily used where very high axial loading is required for challenging static and slow rotary, oscillating applications. This design is best utilized in difficult static sealing applications such as gas, cryogenic temperatures, and vacuum. This spring design can also be used in dynamic applications where high torque and clamping forces are presented.



SES600

Profile	Description
SES600	Symmetrical U-Cup design for radial inner diameter sealing

Seal Materials

Just like hydraulic and pneumatic systems, fluid power transmission systems are utilized in a wide variety of applications and under broad operating and environmental conditions. The seals used in fluid power transmission systems significantly influence the functionality, reliability, and effectiveness, as well as the environmentally-friendly operation of those systems.

Similar to how using the proper type of seal for a given application/system is critical, choosing the appropriate seal material is important for achieving the best possible seal performance. There are a variety of materials to choose from when solving different sealing problems presented by technical, reliability, and environmental challenges. The proper selection of seal material will help to achieve reasonable, expected service intervals and a full service life.

There are four major groups of synthetic polymers available for utilization across a broad range of industrial applications:

- **Polyurethanes:** thermoplastic (AU) and thermoset (EU) polyurethanes (Table 1 shows a list of common polyurethanes)
- **Elastomers (rubbers):** nitrile rubber (NBR), hydrogenated nitrile rubber (H-NBR), ethylene propylene diene monomer rubber (EPDM), fluorocarbon rubbers (FPM), Vinyl Methyl Silicon Rubber (MVQ), tetrafluoroethylene (TFE) (Table 2 shows a list of common elastomers)
- **Fluoroplastics:** PTFE and its different compounds such as bronze-filled, glass, carbon/graphite (Table 3 shows a list of common PTFE compounds)
- **Engineered Hard Plastics:** rigid thermoplastics and thermosets and their different composites (Table 4 shows a list of common engineered hard plastics)

Seal material properties provide and maintain the sealing function of the seal components during the service life. The most important considerations during the material selection process are the following:

- Proper durometer (hardness) and flexibility for tight sealing (sealability) and to avoid leaks
- Proper temperature resistance through a broad temperature range
- Good chemical resistance against utilized medias in order to maintain physical properties of the seal material and seal components, which enables material to be used in wide diversity of hydraulic fluids and medias
- Excellent gap extrusion resistance to withstand elevated system pressure and shear stress caused by fluid pressure
- Ability to maintain the elasticity over a broad operating temperature range
- Elasticity maintained over the expected service life, having resistance against compression set, and good stress relaxation behavior
- Mating surface roughness will create wear on the seal's contact area, which should be reduced as much as possible using wear-resistant material in order to avoid early wear out
- Improved tribological properties by low frictional values
- Proper durometer (hardness) and flexibility for easy installation

(Table 5 summarizes the typical physical properties of the most common seal materials. The data and information are intended as only a guide to be used.)

TABLE 1 – POLYURETHANES

Polyurethanes				
Material Code	Description	Color	Durometer Shore A	Available Sizes
AWC800	Thermoset polyether urethane (EU)	Dark maroon	95	ID of 10 mm (0.394") up to an unlimited OD utilizing our exclusive fusion process.
AWC825	Thermoset polyether urethane (EU)	Dark blue	85	ID of 10 mm (0.394") up to an unlimited OD utilizing our exclusive fusion process.
AWC830	Thermoset polyether urethane (EU) FDA	Off white	94	ID of 10 mm (0.394") up to an unlimited OD utilizing our exclusive fusion process.
AWC860	Thermoset polyether urethane (EU) high temp	Bright red	95	ID of 10 mm (0.394") up to an unlimited OD utilizing our exclusive fusion process.

Seal Materials

TABLE 2 – ELASTOMERS

Elastomer				
Material Code	Description	Color	Durometer Shore A	Available Sizes
AWC742	NBR	Black	85	ID of 10 mm (0.394") up to an OD of 1400 mm (55").
AWC743	H-NBR	Green	85	ID of 10 mm (0.394") up to an OD of 1400 mm (55").
AWC752	EPDM	Black	85	ID of 10 mm (0.394") up to an OD of 1400 mm (55").
AWC727	TFE/FEPM	Black	85	ID of 10 mm (0.394") up to an OD of 965 mm (38").
AWC704	FPM	Black	85	ID of 10 mm (0.394") up to an OD of 1400 mm (55").

TABLE 3 – FLUOROPLASTICS

Fluoroplastics				
Material Code	Description	Color	Durometer Shore D	Available Sizes
AWC100	PTFE Polyimide filled	Dark yellow	57	ID of 1.20 mm (0.50") up to an OD of 2032 mm (80").
AWC300	PTFE Glass + MoS ₂ -filled	Dark grey	56	ID of 1.20 mm (0.50") up to an OD of 2032 mm (80").
AWC400	PTFE Carbon/graphite-filled	Black	62	ID of 1.20 mm (0.50") up to an OD of 2032 mm (80").
AWC500	PTFE Bronze-filled	Bronze	67	ID of 1.20 mm (0.50") up to an OD of 2032 mm (80").
AWC510	PTFE Mineral filled-FDA	White	66	ID of 1.20 mm (0.50") up to an OD of 2032 mm (80").
AWC520	PTFE unfilled	White	62	ID of 1.20 mm (0.50") up to an OD of 2032 mm (80").

TABLE 4 – ENGINEERED HARD PLASTICS

Engineered Hard Plastics					
Material Code	Description	Color	Durometer Shore D	Material Characteristics	Typical Uses
AWC650	POM Polyacetal	Black	85	Excellent creep resistance under continuous load, fatigue as well as endurance under repeated cycles.	Anti-extrusion rings for dynamic and static applications, wear rings guiding components in light- and medium-duty applications, gland adapters for V-Ring sets.
AWC665	PA6 Nylon MoS ₂ -filled	Black	85	Better wear properties with MoS ₂ than unfilled material. Bearing material. Compressive strength 100 –110 MPa (14,500 –15,950 psi).	Anti-extrusion rings for dynamic and static applications, wear rings and guiding components in medium- and heavy-duty applications, gland adapters for V-Ring sets.
AWC630	PEEK unfilled	Tan	86	Better wear characteristics. Tough, reliable, and dimensionally stable, even under continuous elevated temperatures. Excellent wear characteristics for seals and wear rings.	Anti-extrusion rings for dynamic and static applications, wear rings and guiding components in heavy-duty applications, spring energized seals.
AWC635	PEEK glass-filled	Cream	88	Designed for improving the wear rate of unfilled PEEK (AWC630) in high performance applications. Tough, reliable, and dimensionally stable, even under continuous elevated temperatures. Good backup ring material in backup ring applications.	Anti-extrusion rings for dynamic and static applications, wear rings and guiding components in heavy-duty applications, spring energized seals.
AWC615	UHMWPE	White	68	Excellent low friction and wear material. Great option for low temperature applications. Rated from -162°C to 110°C. High impact strength material resistant to chemical attack and moisture absorption.	Anti-extrusion rings for dynamic and static applications, wear rings guiding components in light and medium-duty applications, gland adapters for V-Ring sets.

Fluid Compatibility Guide

COMPATIBILITY RATING: C...Compatible NR...Not recommended M...Generally not recommended PEEK™ is a trademark of Victrex plc.
 The Fluid Compatibility Guide is intended for use as a reference only. Actual testing should be conducted to determine the suitability of the material in the fluid and application. Results may vary significantly due to varying conditions including temperature, concentration, mixtures and other.

Fluid	PUR (EU)	PTFE (unfilled)	UHMW PE	NBR	FKM	PEEK™	Nylon (Nylon)	POM (Acetal)	Fluid	PUR (EU)	PTFE (unfilled)	UHMW PE	NBR	FKM	PEEK™	Nylon (Nylon)	POM (Acetal)
Acetoyde	NR	C	NR	NR	NR	C	C	C	Arsenic Salts	C				NR		C	
Acetamide	NR	C	C	C	NR		C	C	ASTM Oil #1	C	C		M	M			
Acetate Solvent	NR	C	C	NR	NR		C		ASTM Oil #2	M	C		M	M			
Acetic Acid	NR	C	C	NR	NR	C	NR	NR	ASTM Oil #3	M	C		M	M			
Acetic Acid, 20%	M	C	C	NR	NR		NR	M	ASTM Reference Fuel A	NR	C		M	M			
Acetic Anhydride	NR	C	NR	NR	NR		C	NR	ASTM Reference Fuel B	M	C		NR	M			
Acetone	NR	C	M	NR	NR	C	M	C	Barium Carbonate	M	C	M	C	M		C	C
Acetyl Bromide	NR	C		NR			NR		Barium Chloride	M	C	C	C	C	C	C	C
Acetyl Chloride	NR	C		NR	NR				Barium Cyanide		C	M	NR	C		C	M
Acetylene	NR	C	NR	C	C	C	C	C	Barium Hydroxide	C	C	M	C	C		C	NR
Acrylonitrile	NR	C	C	NR	NR	C	C		Barium Nitrate	NR	C	M	C	C		C	M
Adipic Acid	C	C	C	M	C				Barium Sulfate	M	C	M	C	C		C	M
Aluminum Chloride	M	C	M	C	C	C	M		Barium Sulfide	M	C	M	C	C	C	C	C
Aluminum Fluoride	NR	C	C	C	C		C	M	Benzaldehyde	NR	C	C	NR	NR	C	C	C
Aluminum Hydroxide	NR	C	C	C	C		C	C	Benzene (Gasoline)	NR	C	NR	NR	NR	C	C	C
Aluminum Nitrate	NR	C	C	C	C		C	M	Benzenesulfonic Acid	NR	C	C	NR	NR		NR	
Alum. Potassium Sulfate		C	C	C	C		NR	M	Benzoic Acid	NR	C	C	NR	C	C	NR	M
Aluminum Sulfate	M	C	C	C	C	C	C	M	Benzol	NR	C	NR	NR	NR		NR	C
Aluminum Sulfide	M	C		C	C				Benzyl Alcohol	NR	C	NR	NR	C	C	M	C
Amines		C	NR	NR	NR		NR	NR	Boric Acid	C	C	C	M	C	C	M	C
Ammonia/Cold	M	C		C	NR	C	NR		Bromine	NR	C	NR	NR	NR	NR	NR	NR
Ammonia Nitrate		C	C	C	NR		NR	M	Butadiene	NR	C	NR	NR	NR		M	C
Ammonia, Anhydrous	NR	C	M	NR	NR	C	C	NR	Butane	C	C	NR	C	C	C	C	C
Ammonia, Liquid	NR	C	NR	M	NR	C	M	NR	Butyl Acetate	NR	C	NR	NR	NR	C		
Ammonium Acetate	NR	C	C	M	C		C		Butyl Alcohol	NR	C	C	C	C		NR	C
Ammonium Bifluoride		C	C	M	C			NR	Butylene	NR	C	M	M	C		M	C
Ammonium Carbonate	M	C	M	NR	C		C	NR	Butyric Acid	NR	C	NR	NR	NR		M	C
Ammonium Chloride	NR	C	C	NR	C	C	M	M	Calcium Bisulfide	NR	C	M	M	M	C	C	
Ammonium Hydroxide	NR	C	C	NR	NR	C	C	M	Calcium Carbonate	M	C	M	C	C	C	C	C
Ammonium Nitrate	M	C	C	C	C	C	C	C	Calcium Chloride	C	C	M	C	C	C	C	NR
Ammonium Persulfate	M	C	C	NR	NR		NR	NR	Calcium Hypochlorite, 5%	NR	C	C	M	C	C		
Ammonium Sulfate	M	C	C	C	NR		C	M	Calcium Hydroxide	C	C	C	C	C	C	C	NR
Ammonium Sulfide	M	C		C	NR				Calcium Nitrate	M	C		C	C	C	C	NR
Ammonium Thiocyanate	M	C		M	M				Calcium Oxide	NR	C	M	C	M		M	C
Amyl Acetate	NR	C	NR	NR	NR	C	M	M	Calcium Sulfate	M	C	M	C	C	C	NR	NR
Amyl Alcohol	NR	C		M	M		C	C	Carbon Bisulfide	NR			NR	C		C	C
Amyl Chloride	NR	C	NR	NR	C		M	C	Carbon Dioxide	C	C	C	C	NR	C		
Aniline	NR	C	NR	NR	M	C	C	C	Carbon Dioxide (Dry)	A	C	C	C	C	C	C	C
Aniline Hydrochloride	NR	C	NR	NR	NR		NR		Carbon Dioxide (Wet)	NR	C	C	C	NR		C	C
Animal Fats	M	C		M	M	C			Carbon Disulfide	NR	C	NR	NR	C		M	C
Antimony Salts	M			M	M	C			Carbon Monoxide	C	C	C	C	C	C	C	C
Antimony Trichloride	NR	C	M	NR	C	C	NR		Carbon Tetrachloride	NR	C	NR	M	C	C	NR	M
Aqua Regia	NR	C	M	NR	M	NR	NR	NR	Carbonic Acid	M	C	M	NR	C	C	C	M
Aromatic Hydrocarbons	NR		NR	NR	C	C		C	Castor Oil	C	C		C	C			
Arsenic Acid	NR	C	M	C	C		M	NR									

Fluid Compatibility Guide

COMPATIBILITY RATING: C...Compatible NR...Not recommended M...Generally not recommended PEEK™ is a trademark of Victrex plc.
 1 The Fluid Compatibility Guide is intended for use as a reference only. Actual testing should be conducted to determine the suitability of the material in the fluid and application. Results may vary significantly due to varying conditions including temperature, concentration, mixtures and other.

Fluid	PUR (EU)	PTFE (unfilled)	UHMW PE	NBR	FKM	PEEK™	Nylon (Nylon)	POM (Acetal)	Fluid	PUR (EU)	PTFE (unfilled)	UHMW PE	NBR	FKM	PEEK™	Nylon (Nylon)	POM (Acetal)
Chlorinated Glue	NR			M	C	NR		NR	Ethyl Bromide	NR	C		M	C			
Chlorine	NR	C	NR	NR	C	NR	NR	C	Ethyl Chloride	NR	C	NR	C	C		C	C
Chloroacetic Acid	NR	C		NR	NR	C	NR	NR	Ethylene Chloride	NR	C	NR	C	C		C	C
Chlorobenzene (Mono)	NR	M	NR	NR	C	C	NR	NR	Ethylene Chlorohydrin	NR	C	NR	NR	C		NR	NR
Chloroform	NR	C	NR	NR	C	C	C	C	Ethylene Diamine	NR	C	C	NR	NR		NR	NR
Chlorosulfonic Acid	NR	C	NR	NR	NR	NR	NR	NR	Ethylene Dichloride	NR	C	NR	NR	NR		C	M
Chromic Acid	NR	C	NR	NR	M	NR	NR	NR	Ethylene Glycol	M	C	NR	C	C	C	C	M
Chromium Potassium Sulfate	M	C		M	M				Ethylene Oxide	NR	C	C	NR	NR	C	C	NR
Citric Acid	M	C	NR	C	C	C	C	M	Fatty Acids	NR	C	NR	M	C	C	C	C
Clorox (Bleach)		C		NR	C	C	C	NR	Ferric Chloride	M	C	C	C	C	M	C	NR
Copper Chloride	NR	C		C	C	C	NR	C	Ferric Nitrate	M	C	C	C	C	C	C	NR
Copper Cyanide	M	C	M	C	C	C	NR	C	Ferric Sulfate	NR	C	C	C	C	C	C	NR
Copper Fluoborate				NR	C			M	Ferrous Chloride	M	C	C	C	C	C	NR	NR
Copper Nitrate	NR	C	M	C	C	C	NR	C	Ferrous Sulfate	M	C	C	C	M	C	NR	NR
Copper Sulfate 5%		C	C	C	C	C	NR	NR	Fluorine	NR	NR	NR	NR	NR	NR	NR	NR
Copper Sulfate >5%	NR	C	C	C	C	C	NR	NR	Fluoroboric Acid		C	C				NR	C
Cottonseed Oil	C	C		C	C				Fluosilicic Acid	NR	C	C	C	M		NR	C
Cresol (Meta)	NR	NR	NR	NR	M		NR	NR	Formaldehyde	NR	C		NR	NR	C		
Cresylic Acid	NR	C	M	NR	C		NR	NR	Formaldehyde 40%	NR	C	NR	M	C	C	C	C
Cupric Chloride	C	C		NR	M				Formaldehyde 100%	NR	C	M	NR	NR	C	NR	C
Cupric Nitrate	M	C		M	M				Formic Acid	NR	C	NR	NR	NR	M	NR	C
Cupric Sulfate	M	C		M	M	C			Freon 11	NR	C	NR	NR	NR			
Cyclohexanone	NR	C	NR	NR	NR	C	C	C	Freon 12	C	C	C	M	NR	C	C	M
Cyclohexane	M	C	M	C	C	C	C	C	Freon 22	NR	C		NR	NR	C	M	C
Detergents	NR	C	NR	M	C	C		C	Freon 113	NR	C		C	NR	C		C
Diacetone Alcohol	NR	C	M	NR	NR		C	C	Freon Tf	NR	C		C	NR		NR	C
Dibutyl Ether	M	C		NR	NR				Fruit Juice	M	C	C	C	C	C	C	NR
Dibutyl Phthalate	NR	C		NR	NR	C			Furfural	NR	C	NR	NR	NR		M	C
Dichloroethane	NR	C	NR	NR	NR	C	C	C	Gallic Acid	NR	M	C	NR	C		C	
Diesel Fuel	NR	C	NR	C	C	C	C	NR	Gelatin	NR	C	C	C	C	C	C	M
Diethyl Ether	M	C		NR	NR	C	C		Glucose	NR	C	C	C	C		C	C
Diethylamine	NR	NR	NR	NR	NR	C	C	M	Glue, Pva	M	C	C	C	M		C	C
Diethylene Glycol	NR	C	M	C	C		C	C	Glycerin	NR	C	C	C	C		C	C
Dimethyl Acetamide	NR	C							Glycerine (Glycerol)	C	C		C	C	C		
Dimethyl Formamide	NR	NR	C	NR	NR	C	C	NR	Glycolic Acid	M	C	C	NR	NR			C
Diphenyl Oxide	NR	C		NR	C			NR	Propylene Glycol	M	C		M	C			M
Dodecyl Mercaptan	M	C							Gasoline	M	NR	C	C	C	C	C	C
Epson Salts	NR	C	C	C			C	M	Greases	C	C		C	C			NR
Ethane	NR	C		C	C	C	NR	C	Hydraulics Fluids (DIN 51524)								
Ethanol	NR	C	M	NR	NR	C	C	C	HETG (vegetable oil based) Environmentally acceptable fluids	C	C	C	C	C	C	C	C
Ethanolamine	NR	C		M	NR		C	NR	HEES (synthetic ester based) Environmentally acceptable fluids		C		M	C	C	C	C
Ether	M	C	NR	NR	M		C	C	HEPG (polyglycol based) Environmentally acceptable fluids	M	C		M	M	C	C	C
Ethyl Acetate	NR	C	NR	NR	NR	C	C	C									
Ethyl Alcohol	NR	C	M	M			C	C									
Ethyl Benzoate	NR	C	NR	NR	C												

Fluid Compatibility Guide

COMPATIBILITY RATING: C...Compatible NR...Not recommended M...Generally not recommended PEEK™ is a trademark of Victrex plc.
 1 The Fluid Compatibility Guide is intended for use as a reference only. Actual testing should be conducted to determine the suitability of the material in the fluid and application. Results may vary significantly due to varying conditions including temperature, concentration, mixtures and other.

Fluid	PUR (EU)	PTFE (unfilled)	UHMW PE	NBR	FKM	PEEK™	Nylon (Nylon)	POM (Acetal)	Fluid	PUR (EU)	PTFE (unfilled)	UHMW PE	NBR	FKM	PEEK™	Nylon (Nylon)	POM (Acetal)
Hydraulics Fluids (ISO 6743-4)									Ligroin	NR	C	C	C	C		NR	M
HL, HM, HV	C	C		C	C	C	CC		Lime	NR	C	C	C	C	C	C	M
HFA-E (5/95, oil - water emulsion) Fire resistant fluids	C	C		C	C	C	C	C	Linseed Oil	M	C		M	M	C		
HFB (60/40, water-oil emulsion) Fire resistant fluids	NR	C		C	C	C	C	C	Magnesium Carbonate	NR	C	M	M	C			C
HFC (water/glycol) Fire resistant fluids	NR	C		NR	NR	C	C	C	Magnesium Chloride	M	C	C	C	C	C	C	M
HFD (pure synthetic fluids) Fire resistant fluids	NR	C		NR	NR	C	C	C	Magnesium Hydroxide	C	C	C	M	C	C	M	C
HFD-R (phosphate esters) Fire resistant fluids	NR	C		NR	C	C	M	M	Magnesium Nitrate	NR	C	C	C	C		C	C
Heptane	C	C	M	M	C	C	C	C	Magnesium Salts	M	C		C	C			
Hexane	C	C	NR	M	C	C	M	C	Magnesium Sulfate	NR	C	C	C	C	C	C	M
Hexyl Alcohol	NR	C	C	NR	NR		C	C	Malic Acid	NR	C	M	NR	C	C	C	C
Hydrazine	NR	NR		NR	NR	C		M	Melamine	NR	C		NR	C		C	C
Hydrobromic Acid	M	C		NR	C	NR			Mercuric Cyanide		M	C	C	C	C	C	
Hydrobromic Acid 20%	NR		M	NR	C		NR	M	Mercury	M	C	C	C	C	C	C	C
Hydrobromic Acid 100%	NR	C	M	NR	C	NR	NR	NR	Methane	NR	C		C	C	C	C	C
Hydrochloric Acid	NR	C				C			Methanol	NR	C	C	NR	NR	C	M	C
Hydrochloric Acid 20%	M	C	C	NR	C	C	NR	M	Methyl Acetate	NR	C	M	NR	NR		C	M
Hydrochloric Acid 100%	NR	C		NR	NR	C	NR	M	Methyl Acrylate	NR			NR	NR			M
Hydrocyanic Acid	NR	C	C	NR	C	C	M	M	Methyl Alcohol	NR	C	C	NR	NR	C	M	C
Hydrofluoric Acid 50%	NR	C	C	NR	M	NR	NR	NR	Methyl Cellulose	NR	C		NR	NR		M	NR
Hydrofluoric Acid	NR	C		NR	NR	NR	NR	NR	Methyl Chloride	NR	C	NR	NR	C	C	M	M
Hydrofluorosilicic Acid	NR	C	M	NR	C		NR	C	Methyl Dichloride				NR	M		M	NR
Hydrogen	M	C							Methyl Ethyl Ketone	NR	C	M	NR	NR	C	C	M
Hydrogen Gas	M	C	C	C	C		C		Methyl Isobutyl Ketone	NR	C	NR	NR	NR		M	
Hydrogen Peroxide	M	C		M	C	C			Methyl Isopropyl Ketone	NR	C	NR	NR	NR		C	
Hydrogen Sulfide	NR	C	C	NR	NR		M	M	Methylamine		C	C	M	NR			NR
Hydroiodic Acid	M								Methylene Chloride	NR	C	NR	NR	NR	C	M	M
Hydroquinone		C	C	NR	NR		N	C	Mineral Oil	C	C		C	C	C		
Hydroxyacetic Acid 70%	NR	C	C	M	C			C	Mineral Spirits	NR	C	M	C	C		C	C
Iodine Solution	NR	C	C	M	C	M		NR	Monoethanolamine	NR	C	NR	NR	NR		C	NR
Isooctane	M	C		C	C	C	C		Naphtha	NR	M	C	M	C	C	C	C
Isobutyl Alcohol	NR	C	C	NR			C	C	Naphthalene	M	C	NR	NR	C	C	C	C
Isopropyl Acetate	NR	C	M	NR	NR		M	NR	Natural Gas	M	C		C	C	C		M
Isopropyl Alcohol	NR	C	C	M	M	C	NR	C	Nickel Chloride	NR	C	C	C	C	C	M	C
Isopropyl Ether	M	C	M	NR	NR		C	NR	Nickel Salts	NR	C		C	C	C		
Kerosene	M	C	NR	C	C	C	C	C	Nickel Sulfate	NR	C	C	C	C	C	C	C
Ketones	NR	C	NR	NR	NR		C	NR	Nitric Acid	NR	C		NR	NR	NR		
Lacquer Thinners	NR	C	C	NR	NR		C	NR	Nitric Acid 50%	NR	C	M	NR	C	NR	NR	NR
Lactic Acid	M	C	C	C	C	C	M	M	Nitrobenzene	NR	C	NR	NR	M	C	M	M
Lard	NR	C	C	C	C		C	C	Nitrous Acid		C		NR	C			
Latex	NR	C		C	C		C	M	Nitrous Oxide	NR	C	NR	C	C	C	M	
Lead Acetate	M	C	C	NR	NR	C	C	M	Octyl Alcohol	NR		C	NR	NR		C	C
Lead Sulfamate		M	C	M	C		M	C	Oleic Acid	M	C	NR	M	M	C	C	C
									Oleum 25%	NR	C	NR	NR	M		NR	NR
									Oleum 100%	NR	C	NR	NR	NR	NR	NR	NR
									Oxalic Acid (5%)	C	C		M	C	C		
									Oxygen	C	C		NR	C	C		

Fluid Compatibility Guide

COMPATIBILITY RATING: C...Compatible NR...Not recommended M...Generally not recommended PEEK™ is a trademark of Victrex plc.
 1 The Fluid Compatibility Guide is intended for use as a reference only. Actual testing should be conducted to determine the suitability of the material in the fluid and application. Results may vary significantly due to varying conditions including temperature, concentration, mixtures and other.

Fluid	PUR (EU)	PTFE (unfilled)	UHMW PE	NBR	FKM	PEEK™	Nylon (Nylon)	POM (Acetal)	Fluid	PUR (EU)	PTFE (unfilled)	UHMW PE	NBR	FKM	PEEK™	Nylon (Nylon)	POM (Acetal)
Ozone	C	C	C	NR	C	C	NR	M	Sodium Carbonate	M	C	M	C	C	C	M	C
Palmitic Acid	C	C		C	C		C	C	Sodium Chlorate	M	C	M	M	C	C	NR	C
Paints	C-M	C		NR	NR				Sodium Chloride	M	C	C	C	C	C	C	C
Paraffin	M	C	M	M	M	C	C	C	Sodium Chromate		C		C	C		M	NR
Pentane	NR	C	NR	C	C	C	C	M	Sodium Cyanide	M	C	C	C	C		C	C
Perchloric Acid	NR	C	M	NR	C	C	NR	M	Sodium Dichromate	M	C		A	A			
Perchloroethylene	NR	C	NR	M	C	C	M	M	Sodium Ferrocyanide	M	C		C	C			C
Petrolatum	NR	NR	M	C	C		NR	M	Sodium Fluoride	M	C	C	C	C		M	
Phenol (Carbolic Acid)	NR	C		NR	NR		NR	NR	Sodium Hydrosulfite	M	C		NR	NR		C	
Phosphoric Acid	NR	C	M	NR	C	C	M	NR	Sodium Hydroxide 20%		C	NR	C	NR	C	C	C
Phthalic Anhydride	M	C		NR	C	C	M	M	Sodium Hydroxide 45%	M	C			NR	C		
Picric Acid	NR	C	C	NR	C	C	M	C	Sodium Hydroxide 50%		C	NR	NR	NR	C	C	C
Potash	NR		C	C	C		C	M	Sodium Hydroxide 80%		C	NR	NR	NR		M	NR
Potassium Bicarbonate	NR	C	C	C	C	C	C	M	Sodium Hypochlorite 5%	NR	C			NR	C	NR	NR
Potassium Bromide	NR	C	C	C	C	C	C	C	Sodium Hypochlorite 100%	NR	C	M	M	C	C	NR	NR
Potassium Chlorate	M	C	C	C	C	C	M	M	Sodium Metaphosphate	NR	C	C	C	C		C	M
Potassium Chloride	M	C	C	C	C	C	C	C	Sodium Metasilicate	NR	C		C	C			NR
Potassium Chromate	NR	C	C	C	C		M	M	Sodium Nitrate	M	C	C	NR	C	C	C	C
Potassium Cyanide	C	C	C	C	C		C	M	Sodium Perborate	NR	C	C	NR	C		M	M
Potassium Dichromate	NR	C	C	C	C	C	M	C	Sodium Peroxide	NR	C	C	NR	C	C	C	NR
Potassium Ferrocyanide	NR	C	C	NR	C	C	M		Sodium Polyphosphate		C	C	C	C		C	M
Potassium Hydroxide	NR	C		NR	NR	C	M	C	Sodium Silicate	M	C	C	C	C	C	C	M
Potassium Nitrate	M	C	M	C	C	C	M	C	Sodium Sulfate	M	C	C	C	C	C	C	M
Potassium Permanganate	NR	C	C	NR	C	C	NR	C	Sodium Sulfide	M	C		C	C	C	C	M
Potassium Salts	M	C		C	C				Sodium Tetraborate	NR	C	C	C	C		C	M
Potassium Sulfate	M	C	C	C	C	C	C	M	Sodium Thiosulfate (Hypo)		C	C	M	C		M	M
Potassium Sulfide	M	C	C	C	C	C	C		Soybean Oil	M	C		C	C			
Propane	M	C	NR	C	C	C	C	C	Stannic Chloride	NR	C	C	C	C	C	M	M
Propyl Alcohol	NR	C	C	NR	C	C	NR	C	Stannous Chloride	NR	C	M	C	C	C	M	
Propylene Glycol	NR	C	M	C	C		C	M	Starch	A	C	M	C	C	C	C	C
Pyridine	NR	C	M	NR	NR	C	M	M	Steam	NR	C		NR	NR	C		
Pyrogalllic Acid	NR	C		NR	C			NR	Stoddard Solvent	NR	C	NR	C	C		C	C
Rosins	NR	C	M	C	C		C	M	Styrene	M	C		NR	M		C	C
Seawater	C	C	C	C	C		C	C	Sugar (Liquids)		C		C	C		C	C
Shellac (Bleached)	NR	C	C	C	C		C	C	Sulfate (Liquors)	NR	C	C	NR	C		M	NR
Silicic Acid	M	C		A	A	C			Sulfur Chloride	NR	C	NR	NR	C	C	C	NR
Silicone		C		C	C	C	C	C	Sulfur Dioxide	NR	C		NR	C	C	M	M
Skydrol Oil (500)	NR	C		NR	NR				Sulfur Dioxide (Dry)	NR	C	C	NR	C		M	M
Silver Bromide		C	C	NR				M	Sulfur Hexafluoride	NR		M	NR	NR	C	M	
Silver Nitrate	M	C	C	M	C	C	C	C	Sulfur Trioxide	NR	C		NR	C	C	NR	
Soap	M	C	NR	C	C	C	C	C	Sulfur Trioxide (Dry)	NR	C	NR	NR	C		C	NR
Sodium Acetate	M	C	C	M	NR	C	M	M	Sulfuric Acid 10-50%	NR	C		NR	NR	M		
Sodium Aluminate		C		C	C		C	M	Sulfuric Acid 50-75%	NR	C	C	NR	NR	NR	NR	NR
Sodium Bicarbonate	M	C	C	C	C	C	C	C	Sulfuric Acid 75-100%	NR	C	M	NR	NR	NR	NR	
Sodium Bisulfate	M	C	C	C	C		C	M	Sulfuric Acid <10%	NR	C	C		C	M	M	NR
Sodium Borate	M	C	C	C	C		C		Sulfuric Acid (Cold Conc)		C	NR		C		NR	

Fluid Compatibility Guide

COMPATIBILITY RATING: C...Compatible NR...Not recommended M...Generally not recommended

PEEK™ is a trademark of Victrex plc.

† The Fluid Compatibility Guide is intended for use as a reference only. Actual testing should be conducted to determine the suitability of the material in the fluid and application. Results may vary significantly due to varying conditions including temperature, concentration, mixtures and other.

Fluid	PUR (EU)	PTFE (unfilled)	UHMW PE	NBR	FKM	PEEK®	Nylon (Nylon)	POM (Acetal)
Sulfuric Acid (Hot Conc)		C	NR		C		NR	
Sulfurous Acid	NR	C	M	NR	M	C	NR	M
Tallow	A	C	NR	C	C	C	C	C
Tannic Acid 10%	C	C		C	C	C		
Tanning Liquors	NR	C	C	NR	C		C	M
Tartaric Acid	C	C	C	C	C	C	M	M
Tetrachloroethane	NR	C		NR	C		M	C
Tetrachloroethylene	NR	C	M	NR	C		C	C
Tetrahydrofuran	NR	C	NR	NR	NR	C	C	C
Tin Salts	M	C		C	C			
Titanium Salts	M			NR	M			
Toluene	NR	C	NR	NR	C	C	C	M
Transformer Oil	M	C		C	C	C		
Trichloroacetic Acid	NR	C	C	NR	NR		M	
Trichloroethane	NR	C		NR	C	C	M	C
Trichloroethylene	NR	C	NR	NR	C	C	M	NR
Trichloropropane	M	C		NR	M			C
Tricresyl Phosphate	NR	C	M	NR	M		C	M
Triethanol Amine	M	C		NR	NR			NR
Trisodium Phosphate	M	C	C	C	C		M	C
Turpentine	NR	C	NR	C	C	C	M	C
Urea	M	C	C	NR	C	C	C	C
Uric Acid	NR	C	M	NR			C	
Varnish	M	C	C	M	C	C	C	C
Vegetable Oil	C	C		C	C	C		
Vinegar	NR	C	C	M	NR	C	C	M
Water	C	C	C	C	M	C	C	C
Water Acid, Mine	NR	C	C	C	C		C	C
White Liquor	NR	C	C	C	C		C	NR
Xylene	NR	C	M	NR	C	C	C	C
Xylol	NR	C		NR	C			
Zinc Chloride	M	C	C	C	C	C	C	M
Zinc Sulfate	M	C		C	C	C	C	M

Application of ISO Standards Fits and Tolerances

The examples below illustrate how fits and tolerances can be applied to dimensioning one or more components of the cylinder for metric and inch sizes.

Tolerance Recommendations

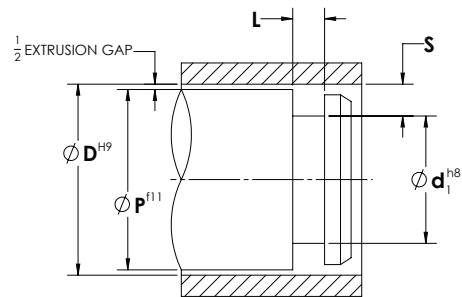
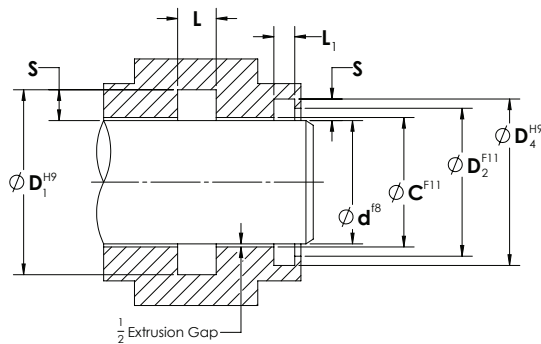

ROD APPLICATION

Dimensions	Rod Seal Profile Group			
	U-Cups	Cap Seals	Compression Seals	Stacked Sets
d	f8	f8	f8	f8
D ₁	H10	H8	H8	H9
C	F11	F11	F11	F11
L	+380.00/-0 (+.015/-0)	+200.00/-0 (+.008/-0)	+250.00/-0 (+.01/-0)	-
L ₃	-	-	-	+250.00/-0 (+.01/-0)

mm tolerances values given in μm (.001 mm)

PISTON APPLICATION

Dimensions	Piston Seal Profile Group				
	U-Cups	Cap Seals	Compression Seals	Stacked Sets	Piston Cup
D	H9	H8	H8	H10	H10
d ₁	-	h8	h9	h8	-
d ₄	-	-	-	-	f11
d ₅	f11	-	-	-	-
d ₆	-	-	f8	-	-
CH	-	-	-	-	h10
P	f11	f11	f11	f11	-
L	+380.00/-0 (+.015/-0)	+200.00/-0 (+.008/-0)	+250.00/-0 (+.01/-0)	-	+100.00/-0 (+.004/-0)
L ₄	-	-	+100.00/-0 (+.004/-0)	-	-
L ₃	-	-	-	+250.00/-0 (+.01/-0)	-

mm tolerances values given in μm (.001 mm)

Application of ISO Standards Fits and Tolerances

Dimensions	Wiper Profile Group			
	Standard Wiper	Canned Wiper	Double Acting Wiper	WCCS Wiper
d	f8	f8	f8	f8
D ₄	H9	H8	H10	H9
D ₂	H10	-	H10	H10
C	F11	F11	F11	F11
L ₁	+250/-0 (+.01/-0)	+250/-0 (+.01/-0)	+380/-0 (+.015/-0)	+200/-0 (+.008/-0)

mm tolerances values given in μmm (.001 mm)

Examples

Bore Dimensioning

300.00 mm bore with H9 tolerance

$$D^{H9} = 300.00 \text{ mm } +130/-0$$

Allowable size range = 300.13 – 300.00mm

Piston Diameter Running Clearance

Piston diameter P to fit 300.00 mm bore

$$P^{F11} = 300.00 -56/-376 \text{ mm}$$

Allowable size range = 299.94 – 299.62mm

Piston Seal Groove

300.00 mm bore, piston seal cross section S = 12.00mm

$$= 300.00 - (2 \times 12.00) = 276.00 +0/-130$$

Allowable size range = 276.00 – 275.87mm

Rod Dimensioning

3.00" rod with h9 tolerance

$$d^{f8} = 3.00" -0.0012/-0.003$$

Allowable size range = 2.997 – 2.998"

Gland Inside Diameter Running Clearance

Gland inside diameter to fit 3.00" rod

$$C^{F11} = 3.00 +.009/+0.01"$$

Allowable size range = 3.009 – 3.001"

Rod Seal Groove

3.00 inch rod, rod seal cross section S = .250" $d_1 = D - (2 \times S)$

with h9 tolerance $D_4 = 3.000 + (2 \times .250)$ with H9 tolerance =

$$3.500 +.003/-0$$

Allowable size range = 3.503 – 3.500"

Extrusion Gap

Note the resultant extrusion gap on the seal support lands should always be within published limits for the seal profile and material used. Reference *Allowable Extrusion Gap Table* for AWC material and profile ratings.

Piston seal: diametrical clearance = D – P

For above bore and piston

$$\text{Maximum extrusion gap} = D_{\text{max}} - P_{\text{min}}$$

$$= 300.13 - 299.62 \text{ mm} = 0.51 \text{ mm}$$

Rod seal: diametrical clearance = C – a

For above rod and gland

$$\text{Maximum extrusion gap} = C_{\text{max}} - d_{\text{min}}$$

$$= 3.009 - 2.997 = .012"$$

Miscellaneous Hardware Guidelines—Reciprocating

ROD APPLICATION

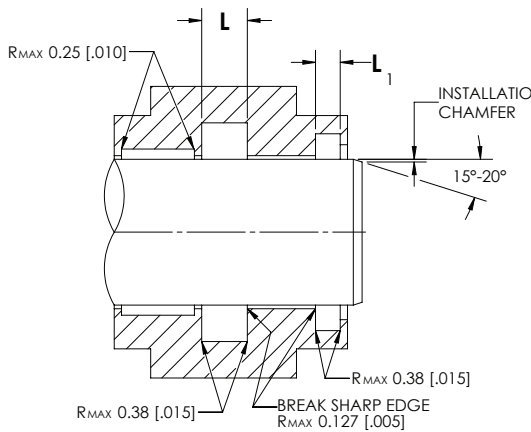

PISTON APPLICATION

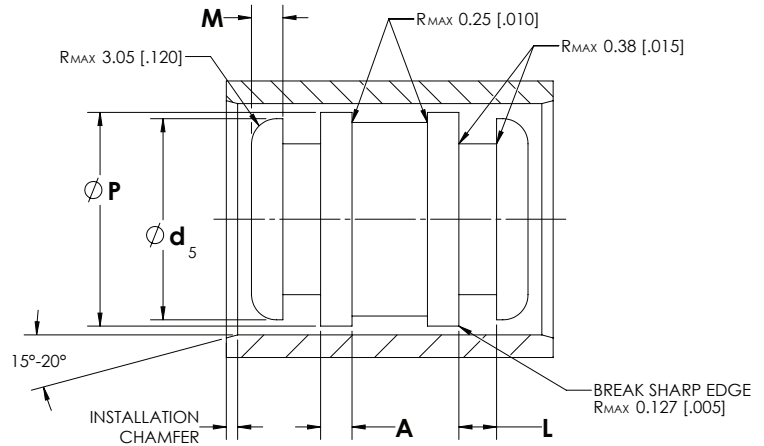

The chart below shows common hardware design guidelines used to ease installation and to protect against damage to seals for typical industrial hydraulic and pneumatic applications.

Note: Piston landing areas A & M = 3.18 mm (0.125") minimum

INSTALLATION CHAMFERS

Seal Cross Section Range (mm/inch)	Chamfer Size (mm/inch)
<3.17 / (0.125)	1.52 / (0.060)
>3.17 - 6.35 / (0.125 - 0.250)	2.03 / (0.080)
>6.35 - 9.53 / (0.250 - 0.375)	2.54 / (0.100)
>9.53 - 12.70 / (0.375 - 0.500)	3.30 / (0.130)
>12.70 - 15.88 / (0.500 - 0.625)	3.94 / (0.155)
>15.88 - 19.05 / (0.625 - 0.750)	4.57 / (0.180)
>19.05 - 22.23 / (0.750 - 0.875)	5.08 / (0.200)
>22.23 - 25.40 / (0.875 - 1.000)	5.59 / (0.220)
> 25.40 / (1.000)	5.84 / (0.230)

Miscellaneous Hardware Guidelines—Reciprocating

The chart below provides recommended groove heights for popular Chesterton seal designs. Piston clearance diameter (d_3) will vary depending on seal profile.

GROOVE HEIGHTS

Profile	Seal Clearance Height $L = H + \text{Clearance}$		Wiper Clearance Height $L_1 = H_2 + \text{Clearance}$		$\text{Ø}d_5$
	L	Tolerance	L_1	Tolerance	
10K, 22KN, 6K	= Seal height H + 1.50 mm (0.062")	+380/-0 (+.015/-0)	NA		= Seal ID + Sea
22K, 22KE, 23K	= Seal height H + 0.76 mm (0.030")	+380/-0 (+.015/-0)	NA		= Seal ID + Sea
20K, 20KD	= Seal height H + 0.25 mm (0.010")	+250/-0 (+.010/-0)	NA		In case of piston applications: Make equal to $\text{Ø}P$
Cap Seals	Up to seal height 4 mm = Seal height + 0.2 mm (0.010") Over seal height 4 mm = Seal height + 0.40 mm (0.016")	+200 /-0 (+.008/-0)	NA		In case of piston applications: Make equal to $\text{Ø}P$
11K	= Seal set height H + 3.2 mm (0.125")	+250/-0 (+.010/-0)	NA		NA
8K, 27K	= 0.98 x Seal set height H	+250/-0 (+.010/-0)	NA		NA
28K	= Seal set height H	+250/-0 (+.010/-0)	NA		NA
5K, 21K, 21KH, 5KT5, 21KT5, 21KR	NA		= Wiper flange height + 0.25 mm (0.010")	+250 /-0 (+.010/-0)	NA
5K Combo, 21KC	NA		= Seal height + 1.50 mm (0.062")	+380/-0 (+.015/-0)	NA
W11-E, W12-E	NA		= Wiper flange height + 0.76 mm (0.030")	+250 /-0 (+.010/-0)	NA
WCCS	NA		= Wiper flange height + 0.25 mm (0.010")	+250 /-0 (+.010/-0)	NA

mm tolerances values given in μmm (.001 mm)

Miscellaneous Hardware Guidelines— Rotary and Reciprocating

Seals made of PTFE and engineered plastic compounds, are usually spring loaded are much more rigid as compared to elastomeric seals and can easily be stretched or compressed beyond their elastic limits at installation. Therefore, it is recommended to utilize an open housing like the two-piece and snap-in designs shown in the charts below.

The drawings below represent typical gland designs for PTFE/engineered plastic seals. Examples include common two-piece and open (snap-in) housing designs.

Piston Mount:

Two-piece housing

Snap-in housing

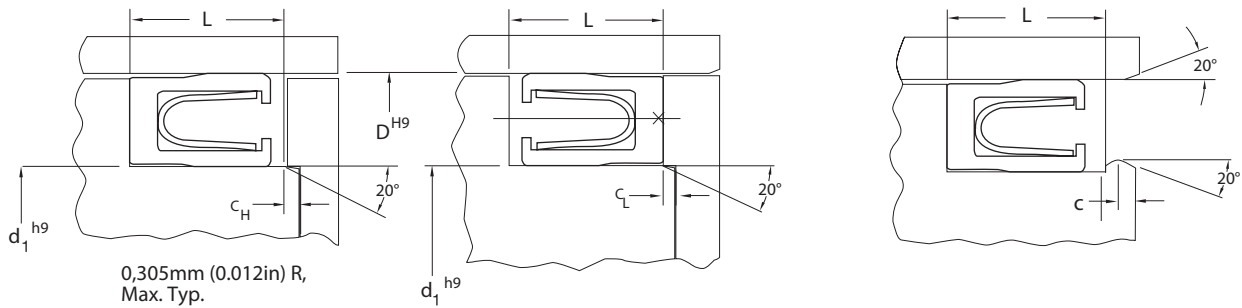

Rod Mount:

Heel first

Lips first

Heel first

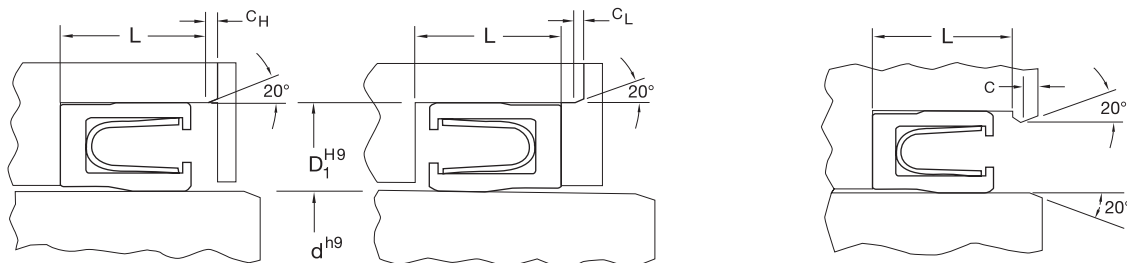

Note: maximum groove radius = 3.50 mm (0.020")

Seal orientation at installation will dictate how much chamfer is required. Seals going into the groove lips first require a longer chamfer to minimize damage during installation. Use the chart below for recommended chamfer.

Seal Cross Section Range mm (inch)	Chamfer C mm (inch)	Installation Chamfer C_H mm (inch)	Installation Chamfer C_L mm (inch)
<2.36 (0.093)	1.14 (0.045)	0.51 (0.020)	1.27 (0.050)
> 2.36 (0.093) – 3.17 (0.125)	1.52 (0.060)	0.76 (0.030)	1.78 (0.070)
> 3.17 (0.125) – 6.35 (0.250)	2.03 (0.080)	1.02 (0.040)	2.29 (0.090)
> 6.35 (0.250) – 9.53 (0.375)	2.54 (0.100)	1.27 (0.050)	3.56 (0.140)
> 9.53 (0.375) – 12.70 (0.500)	3.30 (0.130)	–	–
> 12.70 (0.500) – 5.88 (0.625)	3.94 (0.155)	–	–
> 15.88 (0.625) – 19.05 (0.750)	4.57 (0.180)	–	–
> 19.05 (0.750) – 22.23 (0.875)	5.08 (0.200)	–	–
> 22.23 (0.875) – 25.40 (1.000)	5.59 (0.220)	–	–
> 25.40 (1.000)	5.84 (0.230)	–	–

Note – seals above 12.70 mm (0.500") cross section will utilize two springs.

Miscellaneous Hardware Guidelines— Replaceable Wear Rings

Functions of Non-Metallic Wear Rings

Elastic deformation of the cylinder components under load can cause deflection as well as angular deviations between the rod and gland, and between the piston and cylinder tube. Functions of the non-metallic wear rings are to:

- Create transverse support and longitudinal guide to sliding components
- Enable low friction relative motion between the sliding metallic components
- Enable low wear relative motion between sliding metallic components
- Eliminate metal-to-metal contacts in the cylinders

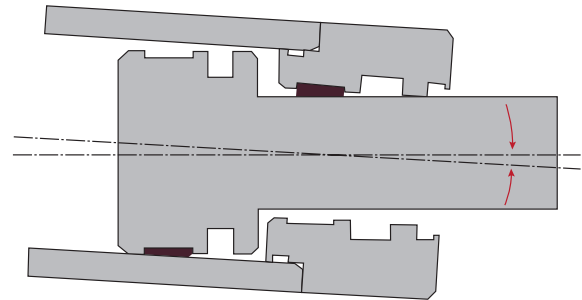

Wear Ring Width Selection

When selecting the guiding width, it is critical to evaluate the transverse loads that the wear rings will have to withstand. Since the system is complex, and because elastic deformation, deflection, and stretching of the components make the calculation difficult, an assumption-based approach is recommended when determining the transverse load that has occurred on the cylinders. The engineering rule of thumb says that even in the most ideal situation, about 10 - 15% of the hydraulic longitudinal force is applied, which can bend the cylinder rods.

The diagram to the right shows the total pressure area (A_p) that the transverse force (F) from a side load will affect. The area A_p is calculated by the $A_p = d \times H_1$, where d is rod diameter with rod wear ring, and H_1 is wear ring height. P_r is the permissible compressive load of the wear ring material.

$$F = P_r \times A_p$$

$$A_p = d \times H_1$$

$$H_1 = \frac{F}{d \times P_r}$$

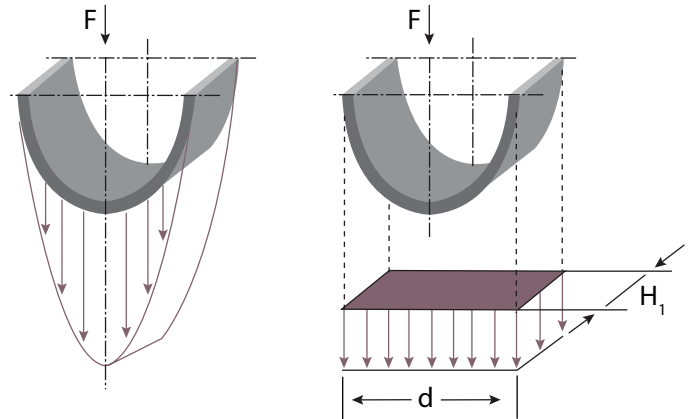

In fact, the pressure distribution is not equally distributed across the area (A_p). That is why it is recommended to use a degradation factor (d_f) that will reduce the calculated load-bearing area, and increase the calculated compressive load on the non-metallic wear ring. The assumed load-bearing area (A_L) can be calculated with a degradation factor of 3 as follows:

$$A_L = A_p = \frac{d \times H_1}{d_f \times 3}$$

Miscellaneous Hardware Guidelines—Replaceable Wear Rings

The transverse force that occurs can vary within wide ranges and cannot be always calculated exactly in advance. Further, we must account for changes in physical properties due to an increase in system temperature. For such cases, a safety factor (sf) of at least 2 is recommended to use for calculations. To calculate the proper bearing height, based on the known transverse force:

$$H_1 = \frac{F \times sf}{d \times P_r}$$

where

F = maximum transverse force (N or pound-force)

sf = safety factor

d = rod nominal diameter with rod wear ring (mm or inch)

P_r = permissible compressive load of the wear ring material (N/mm², MPa or psi)

Permissible compressive load (Pr) can be found in the specifications of the different wear ring materials.

Example:

F = 60,000 N

sf = 2

d = 100 mm

16K AWC640 material Pr 100 N/mm₂ (dynamic at 23°C)

Total = (60,000 Nx2)/(100mmx100N/mm₂) = 12 mm

The closest larger standard groove width has to be selected, which is 15 mm in the case of 16K Wear Ring Strip.

To calculate the allowable radial force F, based on known wear ring height:

$$F = \frac{A_r \times P_r}{sf} = \frac{d \times H_1 \times P_r}{3 \times sf}$$

Standard Chesterton wear rings have a rectangular cross section with chamfered edges. The chamfered edges have two functions:

- Facilitate ease of installation when inserting into the cylinder tube or gland
- Protect against the undesired, impermissible edge forces and stresses in the corner radiuses of the wear ring grooves

18K, 19K, and WR wear rings are delivered ready to fit with the gap necessary for their function. Gaps at the ends of the wear rings are required for the following reasons:

- Compensate for the linear expansion of the rings due to effect of the elevated system temperature
- Protect against the build up of intermediate pressure and entrained pressure



Calculation of the Linear Length

16K and 17K wear ring strips are delivered in coils which must be cut to size manually. The length of the ring can be calculated using the following formula:

Rod application: $L = \pi \times (D - S) - G$ (mm or inch)

Piston application: $L = \pi \times (d + S) - G$ (mm or inch), where

L = Required length of the wear ring (mm or inch)

d = Rod diameter (mm or inch)

D = Piston diameter (mm or inch)

S = Cross section of the wear ring

π = 3.1415 (constant)

G = Required gap (mm or inch)

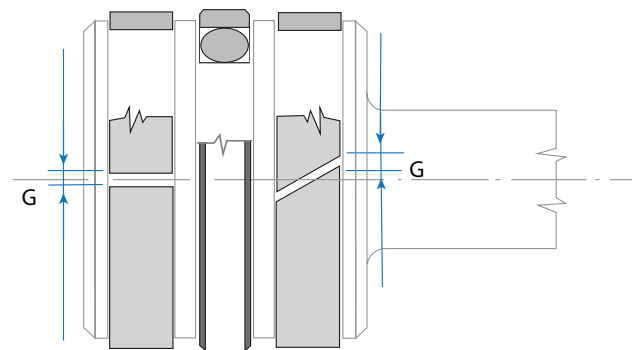

Cutting Instruction		
Outside Diameter mm (inch)	Gap mm (inch)	Tolerance μmm (inch)
> 300 (12.00) < 635 (25.00)	5 (.20)	+/- 0.762 (.003)
> 635 (25.00) < 1.000 (40.00)	7 (.275)	+/- 0.762 (.003)
> 1.000 (40.00)	9 (.355)	+/- 0.762 (.003)

Miscellaneous Hardware

Guidelines—Replaceable Wear Rings

Wear Ring Groove Diameters

The chart below gives dimensional data for hardware clearances and groove design for all Chesterton replaceable wear rings. The use of replaceable wear rings necessitates larger clearance gaps for the minimization of metal-to-metal contact. Consequently, the resulting extrusion gap will be larger for the seal support land. Always ascertain whether the clearance obtained from this chart is within the allowable ratings for the seal material used.

Piston mount: $d_2 = D - (2 \times S)$ with f8 tolerance

Rod mount: $D_3 = d + (2 \times S)$ with F8 tolerance

Piston and Gland Clearance Diameters

Piston diameter P = Actual bore – “piston to bore clearance” and “tolerance” from chart

Gland inside diameter C = Actual rod + “rod to gland clearance” and “ISO tolerance” from chart

Example 1: 200 mm bore with S = 2.50 mm Example 2: 2.500" rod with S = .125"

$$d_2 = (200.00 - [2 \times 2.50]) - 0.05/-0.115 = 195.00 + 0.005/-0.122$$

$$D_3 = (2.500 + [2 \times .125]) + .003/+0.0012 = 2.75 + .003/+0.0012$$

$$\text{Size range with tolerance} = 194.95 - 194.878 \text{ mm}$$

$$\text{Size range with tolerance} = 2.753 - 2.762''$$

$$P = 200.00 - 0.48 = 199.52 + 0/-0.10$$

$$C = 2.500 + .018 = 2.518 + .003/-0$$

$$\text{Size range with tolerance} = 199.52 - 199.42 \text{ mm}$$

$$\text{Size range with tolerance} = 2.521 - 2.518''$$

$$\text{Extrusion gap} = 200 \text{ mm} - 199.88 = 0.22 \text{ mm}$$

$$\text{Extrusion gap} = 2.521 - 2.500 = 0.021''$$

Wear Ring Groove Dimensions							
Dia. Range Basic Size mm (inch)		Piston to Bore Clearance mm (inch)		Rod to Gland Clearance mm (inch)		ISO Tolerance mm (inch)	
Min.	≤ Max.	(D-P)	Tolerance	(C-d)	Tolerance	F8	f8
–	50 (1.968)	.430 (.017)	+0/-0.050 (+0/-0.002)	.430 (.17)	+0.050/-0 (+0.002/-0)	+0.064/+0.025 (+0.003/+0.001)	-0.025/-0.064 (-0.009/-0.003)
50 (1.968)	120 (4.724)	.460 (.018)	+0/-0.070 (+0/-0.003)	.460 (.018)	+0.070/-0 (+0.003/-0)	+0.090/+0.036 (+0.004/+0.001)	-0.036/-0.090 (-0.001/-0.004)
120 (4.724)	250 (9.842)	.480 (.019)	+0/-0.100 (+0/-0.004)	.480 (.019)	+0.100/-0 (+0.004/-0)	+0.122/+0.050 (+0.005/+0.002)	-0.050/-0.122 (-0.002/-0.005)
250 (9.842)	500 (19.685)	.510 (.020)	+0/-0.120 (+0/-0.005)	.510 (.020)	+0.120/-0 (+0.005/-0)	+0.165/+0.068 (+0.007/-0.003)	-0.068/-0.165 (-0.003/-0.007)
500 (19.685)	800 (31.496)	.530 (.021)	+0/-0.150 (+0/-0.006)	.530 (.021)	+0.150/-0 (+0.006/-0)	+0.205/+0.080 (+0.008/+0.003)	-0.080/-0.205 (-0.003/-0.008)
800 (31.496)	1000 (39.370)	.560 (.022)	+0/-0.180 (+0/-0.007)	.560 (.022)	+0.180/-0 (+0.007/-0)	+0.226/+0.086 (+0.009/+0.003)	-0.086/-0.226 (-0.003/-0.009)

mm tolerances values given in mm

Allowable Diametrical Clearance

FIGURE 1

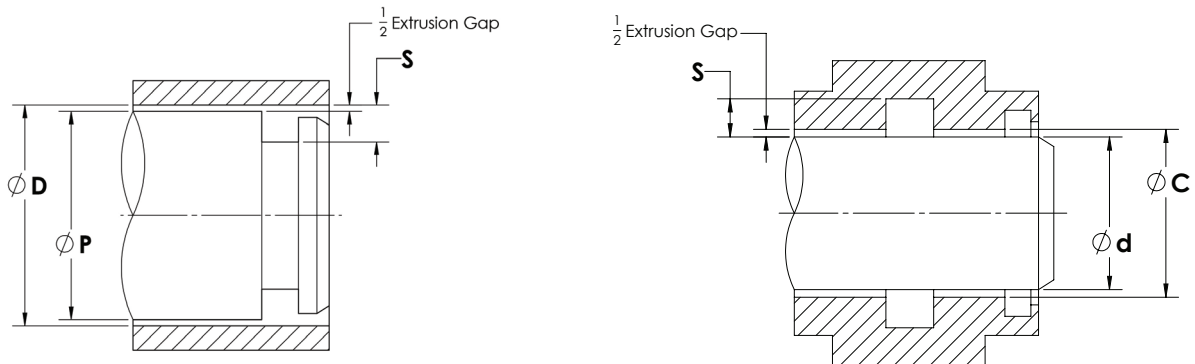

Gap Extrusion

When the seal material is squeezed by fluid pressure into the clearances between components on the unpressurized side, it is called gap extrusion. The dimension of this clearance gap is referred to as the extrusion gap, or "e-gap". The extrusion of the seal is mainly driven by system pressure, as the seal's internal shear stress increases as the system pressure increases. When the shear stress exceeds the physical limit of the seal material it will extrude into the gap. This overload of the seal material will deteriorate the structural integrity of the seal material and result in leaking and physical destruction of the seal.

The ability of a seal to resist extrusion into the gap (called extrusion resistance) depends on the following factors:

- System operating pressure
- System operating temperature
- Size of the clearance gap
- Seal material and design (seal materials with greater durometer and stiffness typically have better resistance to gap extrusion)

The actual size of the extrusion gap is determined by the following factors:

- The nominal gap designed into the cylinder (running clearances)
- Manufacturing tolerances including diametrical variation and geometrical deviations
- Diametrical expansion of the cylinder caused by system pressure
- Transverse force caused by deflection and angular
- Wear on radial load-bearing surfaces

Because all these factors vary, and because the variances can be cumulative, seal design and material must resist extrusion through the largest gap likely to be encountered at design pressure and temperature.

Extrusion Gap

The maximum clearance gap formed between hardware components must be held to a minimum to minimize seal extrusion and premature failure. See *Figure 1* above for typical rod and piston seal extrusion locations. Reference the following tables for maximum values according to system pressure vs. material used. For clearance gaps beyond the recommended values in the tables, the use of a backup ring is recommended.

Allowable Diametrical Clearance

**Polyurethanes
AWC800, AWC860**

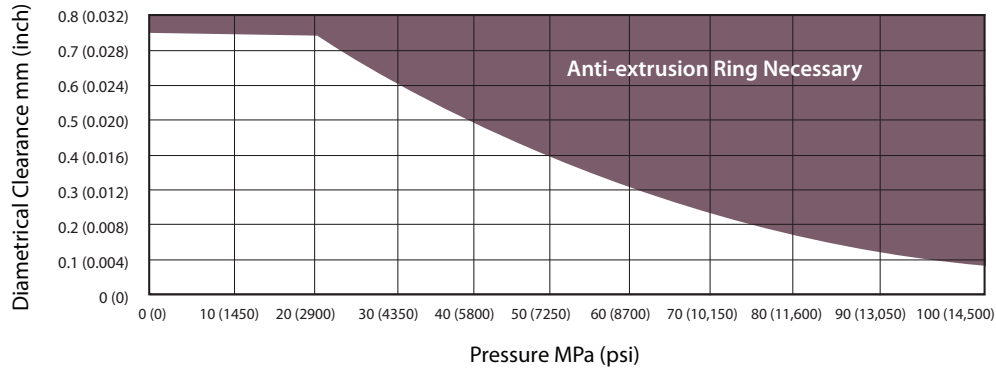

**Polyurethanes
AWC805, AWC825**

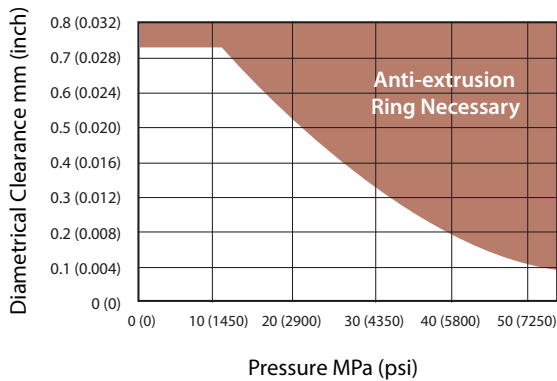

**Polyurethanes
AWC830**

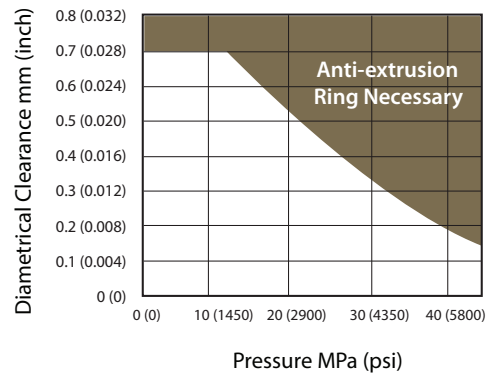

Allowable Diametrical Clearance

Engineered Hard Plastics
AWC650, AWC665

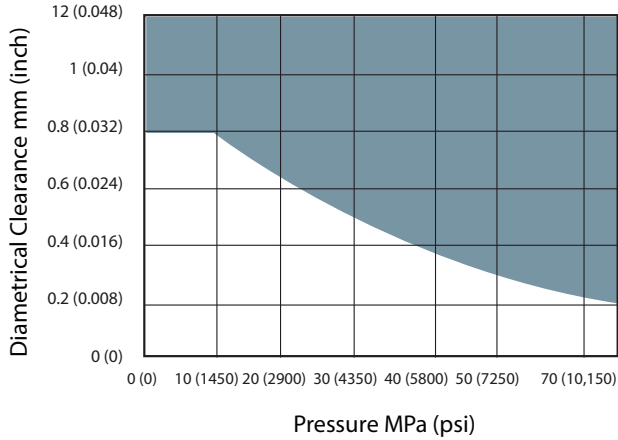

Engineered Hard Plastics
AWC630, AWC635

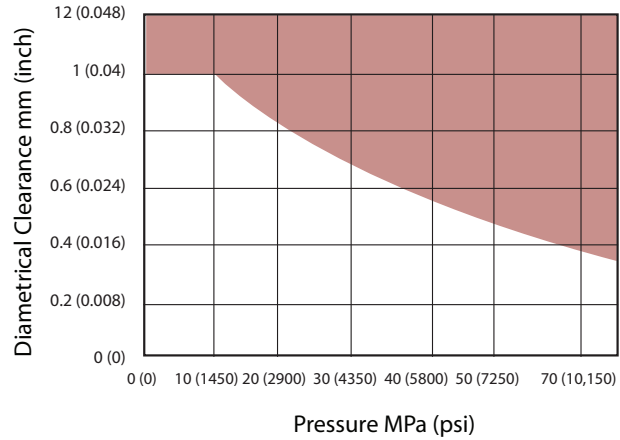

Fluoroplastics
AWC300, AWC500, AWC520

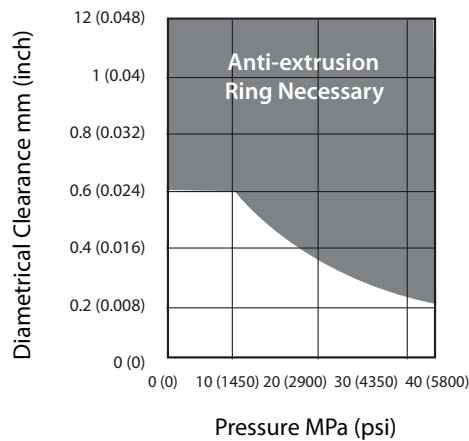

Dynamic Sealing Surface Hardness

Seal components are in continuous physical contact with their dynamic mating surfaces. The relative motion/speed and frictional force generate wear on the seal's dynamic lip contact surfaces as well as on mating surfaces which is why wear resistance of the seal material and mating surfaces will have influence on the equipment life.

A harder mating surface allows for the use of higher wear-resistant seal material, which will increase both the lives of both the seal and hardware surface. Softer surfaces require the use of lower wear-resistant seal materials that will not damage the mating surface; this typically reduces seal life. In the case of harder surfaces, the adhesion between the metal component and the seal is reduced, which results in longer service life for the seal. A balance between seal material and hardware surface should be met to achieve optimum overall sealing performance, and to ensure that the seal is the sacrificial component and not the hardware. *Table 1* shows some of the most popular materials that are used in the manufacture of cylinders and reciprocating equipment's components, and gives a guideline for their average hardness value ranges.

TABLE 1

Material Grades		Typical Hardness Values Rockwell (HRC)		Properties and Typical Application Areas
		Annealed	Hardened	
Carbon Steel	1.0577 (AISI A738)	8 – 10	20	Excellent machinability and weldability. Hydraulic and pneumatic cylinders for agricultural and farm machinery, hoists, automotive and transport lifting equipment, waste disposal transport, food processing equipment, mechanical tools, and equipment.
	1.1181 (AISI 1034)	8 – 10	40 – 45	Widely used in the fields of ship, vehicle, airplane, guided missile, railway, bridges, pressure vessel, machine tools, and mechanical components with a larger sectional size.
	1.1191 (AISI 1045)	8 – 10	50 – 55	High-strength carbon steel, which is mainly used after quenched and tempered. After QT, C45E steel can obtain good comprehensive mechanical properties. Steel is applied to manufacture high-strength moving parts, such as air compressors, piston pumps, heavy duty and general machinery with rolling shafts, connecting rods, worm, rack, or gear.
Alloy Steel	1.5217 (AISI A572)	9 – 10	55 – 60	20MnV6 is a carbon-manganese steel micro alloyed with vanadium, characterized by excellent machinability and weldability, and with high yield and tensile strengths due to the micro alloying effect of the vanadium. 20MnV6 is used extensively by all industry sectors for a wide range of applications utilizing its considerable machinability. Typical applications are chrome plating, cylinders, conveyor rolls, hollow shafts, nuts, and rings.
	1.1303 (AISI 10V45)	20 – 22	50 – 55	Used in hydraulic and pneumatic cylinders that are medium to highly stressed for earth moving, mining, agricultural, waste disposal transport, machine tools, hoists, food processing equipment, compressors, mechanical tools, car jacks, and lifting equipment.
	1.7225 (AISI 4140)	13 – 15	50 – 55	Components with high requirements on toughness. Oil and gas sector, steel industry like collets, connection rods, conveyor pins, stem assemblies, gears, and bearings.
	1.6511 (AISI 4340)	18 – 20	50 – 55	1.6511 steel is a quenched and tempered (Q+T) alloy structural steel that is used for engineering structures. Use when good toughness, and high strength are required, as well as the important conditioning of large size, heavy machinery such as high load of axis, turbine shaft, blade, high load of transmission parts, and fasteners of the crankshaft.
Stainless Steel	1.4305 (AISI 303)	–	19 – 20	Excellent machinability. It is suitable for mass production of components requiring good resistance to atmospheric corrosion and good resistance to many organic and inorganic chemicals. It should not be used in marine environments or coastal environments.
	1.4307 (AISI 304)	–	22 – 23	Good corrosion resistance, impact strength, and formability. The steel has improved machinability. It has good corrosion resistance to uniform corrosion and to many slightly corrosive organic and inorganic chemicals.
	1.4404 (AISI 316)	–	25 – 28	Corrosion-resistant, austenitic stainless steel with good formability. The steel is modified for machining and has very good corrosion resistance.
	1.4125 (AISI 440C)	25 – 27	40 – 45	AISI 440C steel is characterized by good corrosion resistance in mild domestic and industrial environments including fresh water, organic materials, mild acids, and various petroleum products. It has extreme high strength, hardness, and wear resistance when in the hardened and tempered condition. Grade 440C stainless steel is capable of attaining, after heat treatment, the highest strength, hardness, and wear resistance of all the stainless alloys.

Disclaimer: The data and examples are only general recommendations and do not constitute a warranty or a guarantee.

Dynamic Sealing Surface Hardness

Required minimum surface hardness is dependent on operating conditions, velocity, pressure, tribological conditions, and work environment conditions, utilized seal materials, components, and their seal systems. Low-speed and/or low-pressure applications require lower surface hardness values, while high-speed and/or high-pressure applications require higher surface hardness values. The recommended absolute minimum surface hardness for reciprocating applications is HRC 35. For optimum performance, the recommended minimum surface hardness value is 50 HRC.

Seal and equipment performance can be further improved by the use of a piston rod of chrome-plated steel. The chrome plating has good sliding properties, which reduces friction and increases the surface hardness to the range of HRC 60 – 65. Additional improvement can be achieved by hard chrome plating on the hardened rod surface, where the hardened surface has a minimum HRC hardness and a hardening depth minimum of 2.5 mm (0.1 inch). Table 2 summarizes the most common coating and plating methods, which are used in fluid power reciprocating applications.

TABLE 2

Plating or Coating Method		Max Hardness HRC	Typical Thickness mm (inch)	Corrosion Resistance	Abrasive Affect on Seal Components
Chrome plating	Hard chrome	65	0.02 – 0.127 (0.0008 – 0.005)	Fair	Excessive
	Thin dense chrome	70	0.005 – 0.015 (0.0002 – 0.0006)	Excellent	Moderate
Plasma spray coating	Aluminum oxide	65	0.13 – 0.76 (0.005 – 0.030)	Excellent	Moderate
	Chromium oxide	70	0.13 – 0.76 (0.005 – 0.030)	Excellent	Moderate
High velocity oxygen fuel	Tungsten carbide	75	0.13 – 0.76 (0.005 – 0.030)	Excellent	Moderate
Electroless nickel plating	Nickel as deposited	50	0.03 – 0.10 (0.001 – 0.004)	Excellent	Moderate
	Nickel fully hardened	70	0.03 – 0.10 (0.001 – 0.004)	Good	Excessive
Eloxation	Aluminum hard anodic oxidation	50	0.03 – 0.20 (0.001 – 0.008)	Excellent	Moderate

Disclaimer: The data and examples are only general recommendations and do not constitute a warranty or a guarantee.

Surface Roughness

The irregularity of a machined surface is the result of the machining process including the choice of tool, feed and speed of the tool, machine geometry, and environmental conditions. This irregularity consists of high and low spots machined into a surface by the tool bit or a grinding wheel. These peaks and valleys can be measured and used to define the condition and sometimes the performance of the surface.

The dynamic mating surface properties—such as cylinder bore and piston rod to be sealed— properties of the hydraulic cylinders have great influence on the function, reliability, and service life of the seal components and systems. The mating surface property, is a quality commonly described by surface finish or roughness. Surface roughness is a measure of the irregularities (peaks and valleys) produced on a mating/sealing surface according to the manufacturing process used to create the surface.

Adhering to recommended finish ranges can have a profound effect on seal performance by limiting the effects of friction and reducing abrasive seal wear. An optimal surface texture will have ideal pocket depths that retain lubrication in small enough volumes to provide a thin lubrication film between seal and surface thereby reducing friction and seal wear. If the surface is too rough, it will abrade the seal surface by plowing grooves in it and create a leak path. Alternatively, a surface that is too smooth will increase friction and wear because it does not have the ability to retain enough lubrication to provide a boundary lubrication film.

The parameters for specifying a surface finish are defined in ISO 4287, 4288 and DIN 4762 standards. The parameters are measured

or calculated from the roughness mean line. The most commonly used value is Ra arithmetic average, which is the arithmetic mean deviation of the surface profile (Figure 1). The other characteristics frequently used to describe the surface roughness are Rz, which is a peak-to-valley height and Rmax, which is maximum peak-to-valley height (Figure 2).

Calculation of R_z : $R_z = (R_{z1} + R_{z2} + R_{z3} + R_{z4} + R_{z5})/5$

However the Ra, R_z , and Rmax values alone do not describe exactly how the mating surface will affect the seal and how suitable is the mating surface quality for dynamic sealing applications. The Rmr material contact area (or sometimes called material profile bearing length ratio, tp according to ASME 64.1) provides more information about the surface profile characteristics (Figure 3). Ground and polished surfaces will have higher Rmr ratios and lower Ra, R_z , and Rmax values, which provide “seal friendly” surface characteristics. While machined, ground mating surfaces—without polishing—have lower Rmr ratios and higher Ra, R_z and Rmax values, which provide insufficient surface quality for sealing applications. Different surface roughness samples and their material ratio curves with similar Ra and Rz values are shown in Figure 4.

Static surfaces, such as O-Ring groove and mating surfaces or seal groove diameters of dynamic seals, are easier on seals in general. That is why requirements for static surface roughness are less rigorous. Surface roughness value recommendations are distinguished between static and dynamic surfaces. Further surface finish recommendations will vary depending upon the seal material choice as well (see Chart 1).

FIGURE 1 – CALCULATION METHOD OF Ra

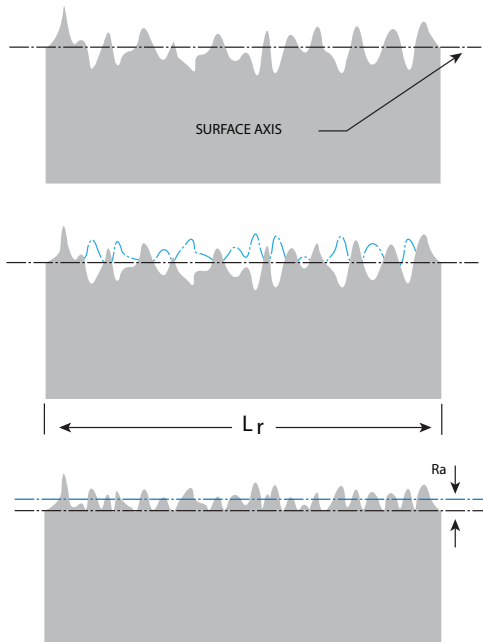
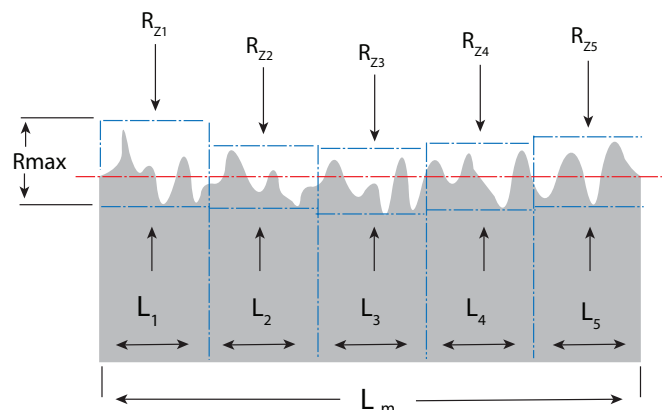

FIGURE 2 – R_z SURFACE VALUE AND CALCULATION OF Rmax



Surface Roughness

FIGURE 3. SURFACE PROFILE AND ITS MATERIAL RATIO CURVE

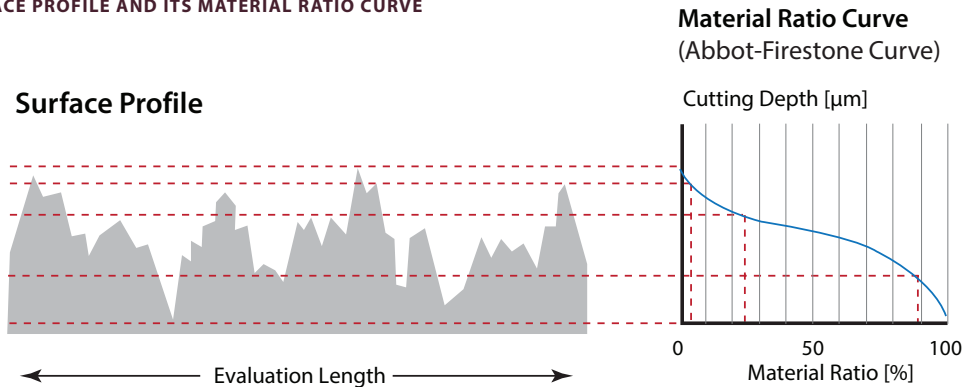

FIGURE 4. SURFACE ROUGHNESS PROFILES AND THEIR MATERIAL RATIO CURVES WITH SIMILAR Ra AND Rz VALUES

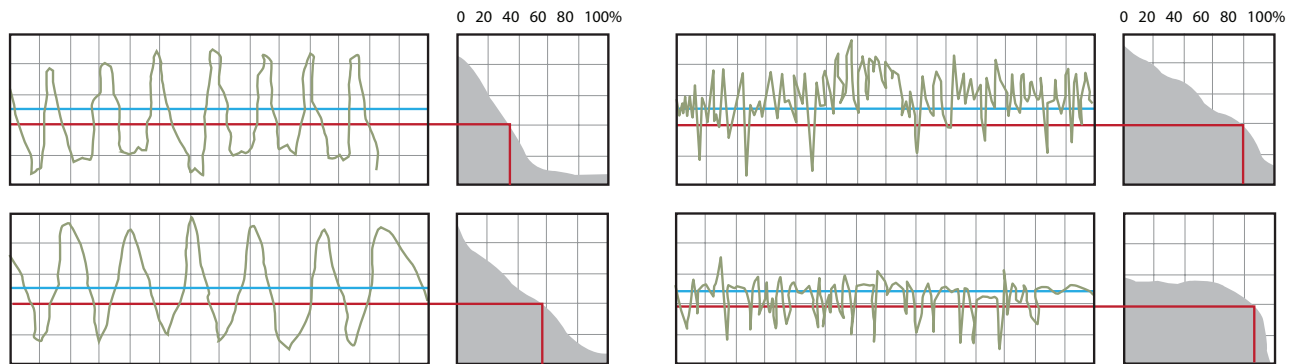

CHART1 - SURFACE ROUGHNESS GUIDELINES

Materials	Surface Roughness Guidelines							
	R _a		R _z		R _{max}		*R _{mr}	
	Dynamic Surface	Static Surface	Dynamic Surface	Static Surface	Dynamic Surface	Static Surface	Dynamic Surface	Static Surface
AWC800, AWC830, AWC860	0.20 – 0.61 µm (8 – 24 µin)	max 1.17 µm (46 µin)	1.60 – 4.80 µm (63 – 190 µin)	max 7.0 µm (280 µin)	1.60 – 4.80 µm (63 – 190 µin)	max 7.0 µm (280 µin)	45% – 75%	nil
Low Durometer Polyurethanes AWC805, AWC825	0.20 – 1.17 µm (8 – 46 µin)	max 1.42 µm (56 µin)	1.60 – 9.40 µm (63 – 370 µin)	max 10.0 µm (400 µin)	1.60 – 9.40 µm (63 – 370 µin)	max 10.0 µm (400 µin)	45% – 75%	nil
Polyurethanes AWC830	0.20 – 0.61 µm (8 – 24 µin)	max 1.17 µm (46 µin)	1.60 – 4.80 µm (63 – 190 µin)	max 7.0 µm (280 µin)	1.60 – 4.80 µm (63 – 190 µin)	max 7.0 µm (280 µin)	45% – 75%	nil
Elastomers AWC: 701, 702, 703, 704, 727, 738, 739, 741, 742, 743, 744, 749, 743, 750, 752, 753, 754, 766, 767, 768	0.10 – 0.3 µm (4 – 12 µin)	max 0.8 µm (32 µin)	0.80 – 2.4 µm (30 – 94 µin)	max 4.8 µm (190 µin)	0.80 – 2.4 µm (30 – 94 µin)	max 4.8 µm (190 µin)	50% – 85%	nil
PTFE Compounds AWC: 100, 200, 300, 400, 425, 500, 510, 520, 530, 540	0.10 – 0.2 µm (4 – 12 µin)	max 0.80 µm (32 µin)	0.80 – 1.6 µm (30 – 64 µin)	max 6.40 µm (250 µin)	0.80 – 1.6 µm (30 – 64 µin)	max 6.40 µm (250 µin)	60% – 90%	nil
PEEK™ Compounds AWC: 630, 633, 635	0.10 – 0.40 µm (4 – 16 µin)	max 0.80 µm (32 µin)	0.80 – 3.20 µm (30 – 126 µin)	max 6.40 µm (250 µin)	0.80 – 3.20 µm (30 – 126 µin)	max 6.40 µm (250 µin)	60% – 90%	nil
UHMWPE Compounds AWC: 610, 615, 620, 625	0.10 – 0.40 µm (4 – 16 µin)	max 0.80 µm (32 µin)	0.80 – 3.20 µm (30 – 126 µin)	max 6.40 µm (250 µin)	0.80 – 3.20 µm (30 – 126 µin)	max 6.40 µm (250 µin)	60% – 90%	nil

*R_{mr} values are determined at a cut depth c=0.25xR_z, relative to a reference level (C_{ref}) at 5% material/bearing area.

Operating Temperature Range

TYPICAL OPERATING TEMPERATURE RANGES BY MATERIAL GRADES

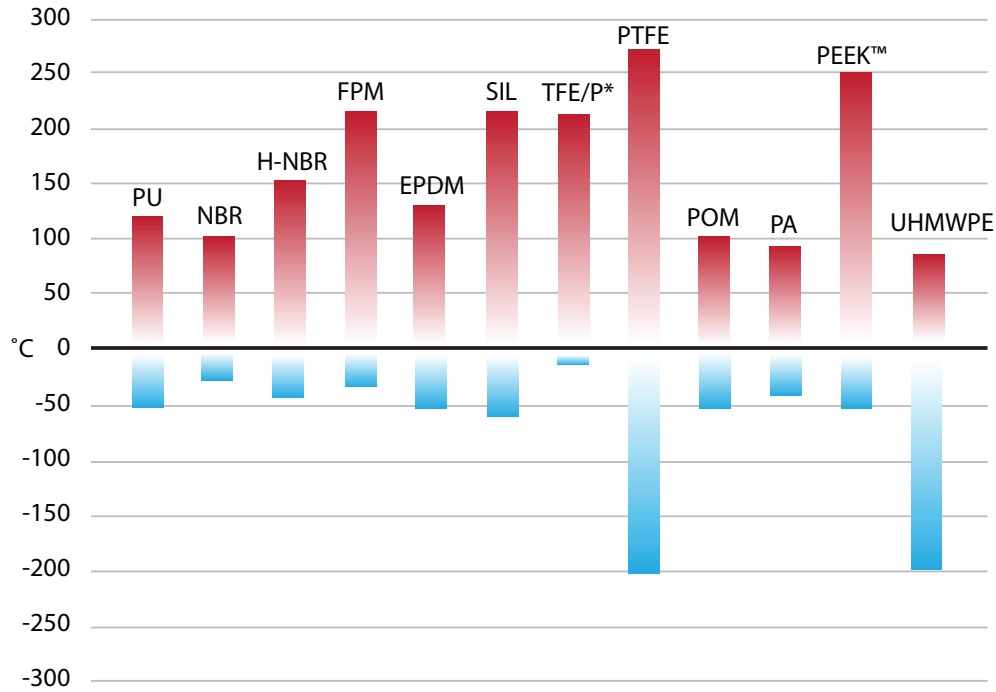

Engineering Action Request Form

CONTACT INFORMATION

Name _____ Date _____
 Company _____ Address _____
 Telephone _____ E-mail _____
 Customer _____

New Tooling Only (Fill out profile and material below)

Seal Profile or Description _____ Material _____

OPERATING CONDITIONS

static reciprocating rotary oscillating

Pressure: psi <input type="checkbox"/> bar <input type="checkbox"/> Operating _____ Min _____ Max _____ Direction: <input type="checkbox"/> Unidirectional pressure <input type="checkbox"/> Bidirectional pressure Vacuum: Yes <input type="checkbox"/> No <input type="checkbox"/>	Speed: ft/min <input type="checkbox"/> m/s <input type="checkbox"/> Stroke length _____ Cycles/min _____ RPM _____	Temperature: C <input type="checkbox"/> F <input type="checkbox"/> Continuous _____ Min _____ Max _____	Media _____ Gas <input type="checkbox"/> Liquid <input type="checkbox"/> Name _____
---	---	--	---

Describe existing seal problem or expectation: _____

Describe existing seal design and material: _____

EQUIPMENT

Application _____ Surface finish _____ R.M.S. Ra
 Manufacturer _____ Hardness _____ Rc
 Model _____ Plating/Coating _____
 Misalignment _____ mm _____ in Eccentricity (T.I.R.) _____ mm _____ in
 (shaft to bore) or Runout

See reverse side for equipment dimensioning.

Describe application and/or operating conditions: _____

Equipment Dimensioning

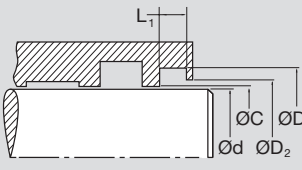
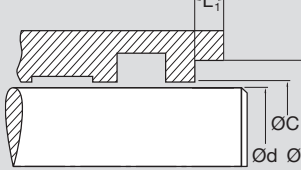
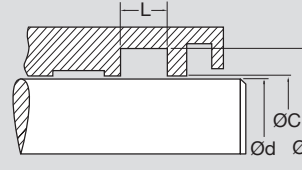
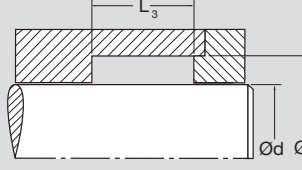
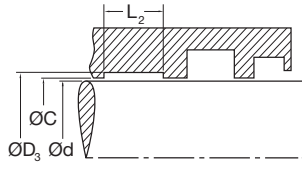
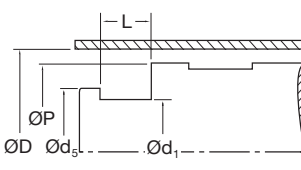
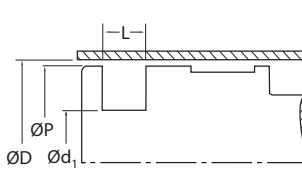
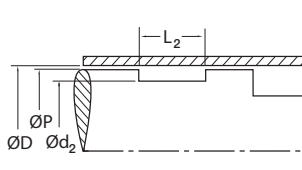
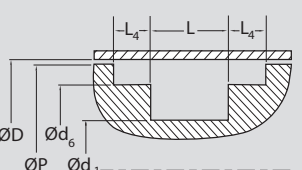
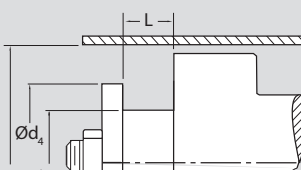
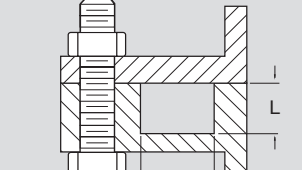
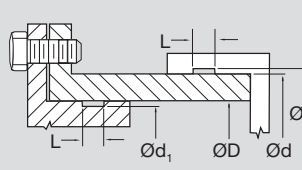
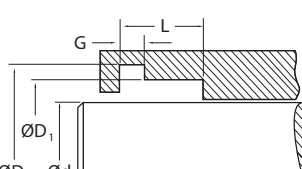
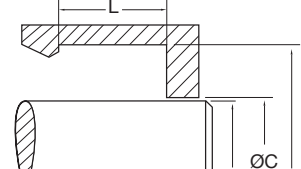
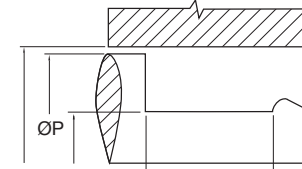
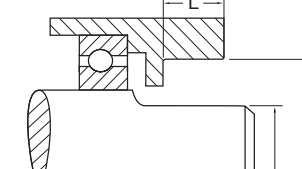
<p>Rod Wiper</p>  <p> Ød: _____ $\text{ØD}_4:$ _____ ØC: _____ $L_1:$ _____ $\text{ØD}_2:$ _____ </p>	<p>Canned Rod Wiper</p>  <p> Ød: _____ $\text{ØD}_4:$ _____ ØC: _____ $L_1:$ _____ </p>	<p>Rod Seal</p>  <p> Ød: _____ $\text{ØD}_1:$ _____ ØC: _____ $L:$ _____ </p>	<p>Rod Packing</p>  <p> Ød: _____ $L_3:$ _____ $\text{ØD}_1:$ _____ </p>
<p>Rod Wear Ring</p>  <p> Ød: _____ $\text{ØD}_3:$ _____ ØC: _____ $L_2:$ _____ </p>	<p>Piston Seal U-Cup</p>  <p> $\text{Ød}_1:$ _____ ØP _____ $\text{Ød}_5:$ _____ $L:$ _____ ØD: _____ </p>	<p>Piston Bidirectional Seal</p>  <p> $\text{Ød}_1:$ _____ ØP: _____ ØD: _____ $L:$ _____ </p>	<p>Piston Wear Ring</p>  <p> ØD: _____ ØP: _____ $\text{Ød}_2:$ _____ $L_2:$ _____ </p>
<p>Bidirectional Piston Seal</p>  <p> $\text{Ød}_1:$ _____ ØP: _____ ØD: _____ $L:$ _____ $\text{Ød}_6:$ _____ $L_4:$ _____ </p>	<p>Piston Cup Seal</p>  <p> ØD: _____ ØCH: _____ $\text{Ød}_4:$ _____ $L:$ _____ </p>	<p>Face Seal</p>  <p> $\text{I.D.:$ _____ $L:$ _____ $\text{O.D.:$ _____ </p>	<p>O-Ring Gland</p>  <p> Piston Mount ØD: _____ $\text{ØD}_1:$ _____ Rod Mount $\text{Ød}_1:$ _____ Ød: _____ $L:$ _____ $L:$ _____ </p>
<p>Flanged Shaft Seal Gland</p>  <p> $\text{ØD}_1:$ _____ $G:$ _____ Ød: _____ $L:$ _____ $\text{ØD}_5:$ _____ </p>	<p>Rod Seal Rotary</p>  <p> $\text{ØD}_1:$ _____ ØC: _____ Ød: _____ $L:$ _____ </p>	<p>Piston Seal Rotary</p>  <p> ØD: _____ ØP: _____ $\text{Ød}_1:$ _____ $L:$ _____ </p>	<p>Rotary Shaft Seal</p>  <p> ØD: _____ $L:$ _____ Ød: _____ </p>

EPS Industrial Cylinder Survey for Reciprocating Applications

Customer: _____
 Contact Name: _____
 Phone/Fax/Email: _____

Project/Job/Reference #/Kit Name: _____
 Ø Rod: _____ Ø Bore: _____
 Request Date: _____

Application Details

Pressure: _____
 Speed: _____

Temperature: _____
 System Fluid: _____

WIPER

Ød: _____
 ØD₄: _____
 L₁: _____
 X: _____

Snap-In Wiper

W21K W21KF W21KS W21KR
 W21KSR W21K5 W21KC

Canned Wiper

W21K W21K1
 W21K2 W21K3

Available Materials: _____ Material: _____
 Profile: _____ Can Material (AWC650 POM): _____

ROD SEAL

Ød: _____ Profile: _____
 ØD₁: _____ Material: _____
 L: _____ 9K AER: _____

U-Cups

R22KE R22K R22KAER R22KN5 R22KN R23K

20Ks

R20K R20K3

Cap Seals

RCCS RCCS2 RCCS3 RCCS4

Material: _____
 Split: Yes No
 Quantity: _____

Available Materials: **U-Cup/20K:** AWC800, AWC825, AWC830, AWC860, AWC704, AWC742; **Cap Seal:** AWC400, AWC500, AWC800, AWC860; **Loaders:** O-Ring, AWC730, AWC740, AWC715; **Rectangular:** AWC704, AWC742

ROD PACKING

Ød: _____
 ØD₁: _____
 X: _____
 Y: _____
 L₃ (Y-X): _____

Stacked Sets

27K, 8K 11K 600

Profile: _____
 Material: _____
 9K AER: _____
 Material: _____
 Split: Yes No
 Quantity: _____

Available Materials: **27K/8K/11K:** AWC800, AWC805, AWC825, AWC830, AWC860, AWC704, AWC742;
600: AWC735, AWC747

ROD WEAR RING

Ød: _____
 ØD₃: _____
 L₂: _____
 Quantity: _____
 Material: _____
 Profile: _____

Coil 16K & 17K
Available Materials: AWC640

WR 18K, 19K
Available Materials: AWC650, 660, 665

EPS Industrial Cylinder Survey for Reciprocating Applications

U-CUP PISTON SEAL

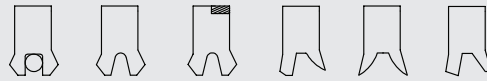
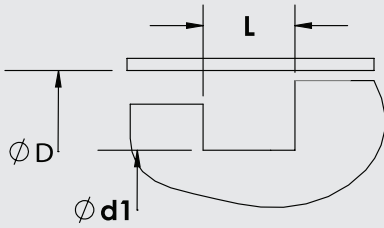

P22KE P22K P22KAER P22KN5 P22KN P23K
Partial AER

Full Radial AER:
Yes No
Split: Yes No

Ød₁: _____ Profile: _____
ØD: _____ Material: _____
L: _____

Available Materials: AWC800, 825, 830, 860, 704, 742

BI-DIRECTIONAL PISTON SEAL

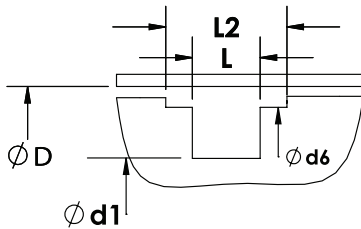

Ød₁: _____
ØD: _____
L: _____
L₂: _____
Ød₆: _____

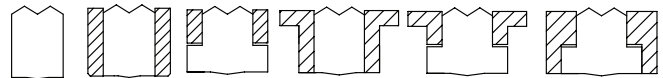

P20K1 P20K2 P20K3 P20K4 P20K5 P20K6

20KHD available in all profiles
Profile: _____
Material: _____

Cap Seals

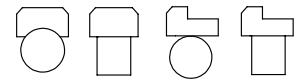

PCCS PCCS2 PCCS3 PCCS4

Available Materials: 20K: AWC800, AWC825, AWC830, AWC860, AWC704, AWC742; Cap Seal: AWC400, AWC500, AWC800, AWC860; Loaders: O-Ring, AWC730, AWC740, AWC715, AWC727; Rectangular: AWC704, AWC742

PISTON WEAR RING

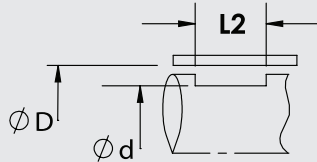

Ød₂: _____
ØD: _____
L: _____
L₂: _____
Quantity: _____
Material: _____

Profiles:

Coil 16K & 17K
Available Materials: AWC640

WR 18K, 19K
Available Materials: AWC650, AWC660, AWC665

STATIC SEAL

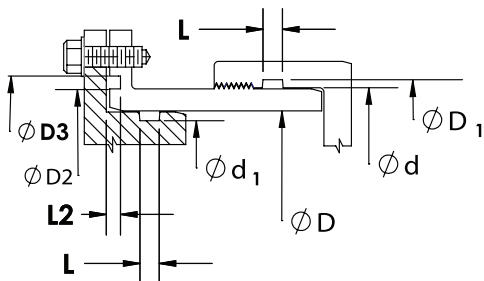

Piston Mount
ØD: _____
Ød₁: _____
L: _____

Rod Mount
ØD₁: _____
Ød: _____
L: _____

Face Seal
ØD₂: _____
ØD₃: _____
L₂: _____

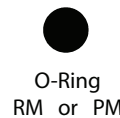

O-Ring
RM or PM

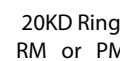

20KD Ring
RM or PM

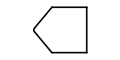

20KDFS

Backup Ring:
Yes No
Split: Yes No
Quantity: _____

Material: _____

Material: _____

Available Materials: 20KD Rings: AWC800, AWC825, AWC830, AWC860, AWC704, AWC742; O-Rings: AWC730, AWC740, AWC715, AWC727

Sealing Technology

Fluid Power Sealing Technology

Cylinder Upgrade—Solutions Approach

The Chesterton cylinder upgrade program applies a systematic solutions approach for improving seal performance during the repair and overhaul of equipment. Working in partnership with you, we offer a unique approach to total cylinder refitting that saves money and delivers a better, more reliable cylinder back to your plant.

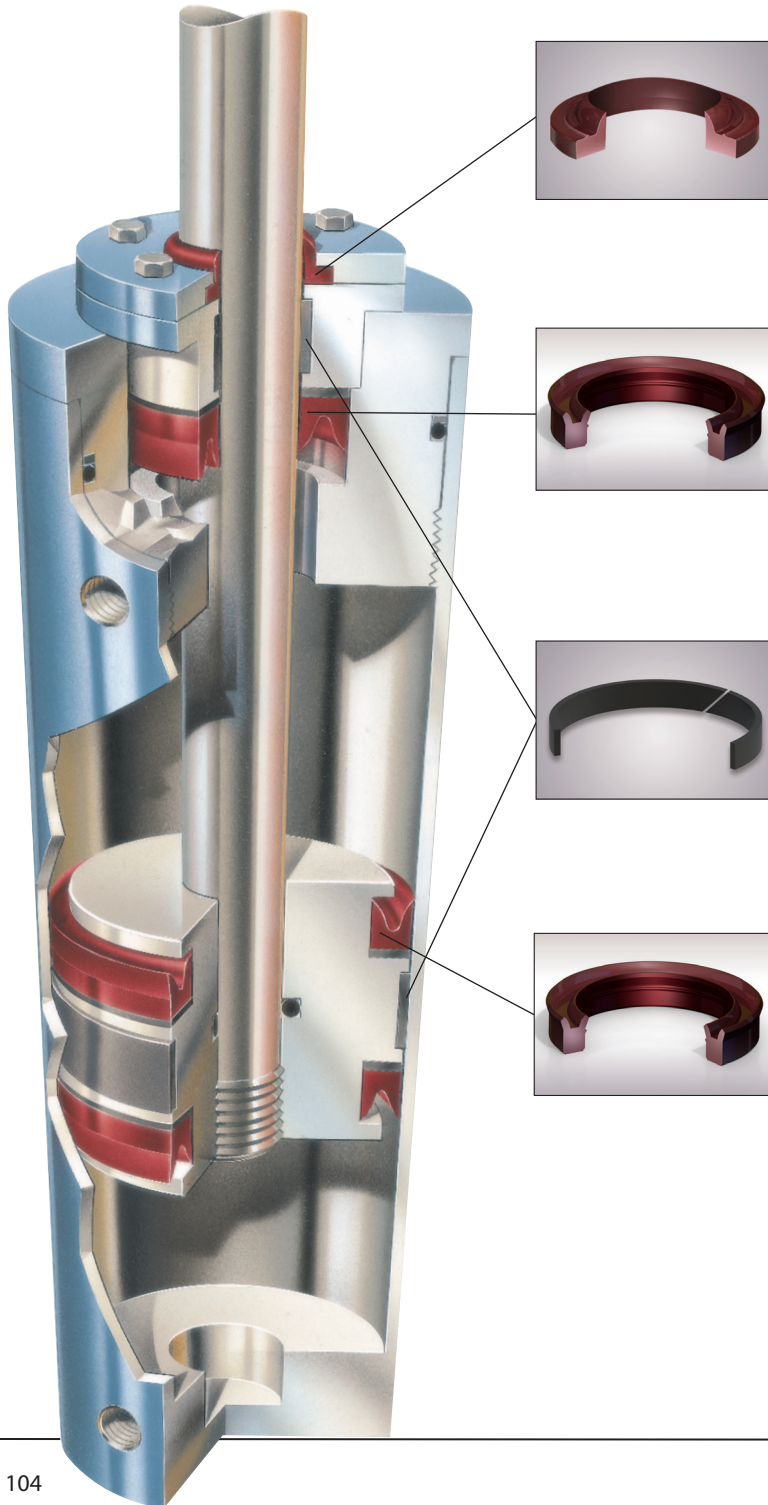

Wiper

The function of a wiper is to effectively clean and to dislodge foreign matter from a reciprocating rod/ram to minimize contaminants from entering the system.

Rod Seal

The function of a rod seal is to act as a pressure barrier and minimize fluid bypass along the dynamic (rod/ram) surface and the static (stuffing box bore) surface under various operating conditions. It regulates the fluid film during extension of the cylinder rod.

Wear Ring

These split, replaceable bearings minimize metal-to-metal contact of moving parts and help prolong equipment and seal life. These bearings reduce radial movement, therefore extending seal life and reducing the risk of reoccurring damage.

Piston Seal

The function of a piston seal is to minimize fluid bypass between the piston head and cylinder bore under various operating conditions and to act as a pressure barrier. It helps to maintain system efficiency and plays an important role in controlling the cylinder motion and maintaining position.



CHESTERTON'S 1, 2, 3 APPROACH

1 *Keep Fluid In*

2 *Keep Contaminants Out*

3 *Support System*



Global Solutions, Local Service

Since its founding in 1884, the A.W. Chesterton Company has successfully met the critical needs of its diverse customer base. Today, as always, customers count on Chesterton solutions to increase equipment reliability, optimize energy consumption, and provide local technical support and service wherever they are in the world.

Chesterton's global capabilities include:

- Servicing plants in over 113 countries
- Global manufacturing operations
- More than 500 Service Centers and Sales Offices worldwide
- Over 1200 trained local Service Specialists and Technicians

Visit our website at chesterton.com



PEEK™ is a trademark of Victrex plc.
SpeedSeal™ is a trademark of A.W. Chesterton Company.

Chesterton ISO certificates available on
chesterton.com/corporate/iso

Technical data reflects results of laboratory tests and is intended to indicate general characteristics only. A.W. Chesterton Company disclaims all warranties express, or implied, including warranties of merchantability and fitness for a particular purpose. Liability, if any, is limited to product replacement only. Any images contained herein are for general illustrative or aesthetic purposes only and are not intended to convey any instructional, safety, handling or usage information or advice respecting any product or equipment. Please refer to relevant Safety Data Sheets, Product Data Sheets, and/or Product Labels for safe use, storage, handling, and disposal of products, or consult with your local Chesterton sales representative.

© 2023 A.W. Chesterton Company.
® Registered trademark owned by A.W. Chesterton Company
in USA and other countries, unless otherwise noted.

Distributed by:



A.W. Chesterton Company
860 Salem Street
Groveland, MA 01834 USA

Telephone: 781-438-7000
Fax: 978-469-6528
chesterton.com

Form No. EN75558
Polymer Seals Engineered Solutions
Product Selection Guide – English
01/23